

FEATURE

- We declare that the material of product is ROHS compliant and halogen free.
- S- Prefix for Automotive and Other Applications Requiring Unique Site and Control Change Requirements; AEC-Q101 Qualified and PPAP Capable.

DEVICE MARKING AND ORDERING INFORMATION

Device	Marking	Shipping
MBT4413DW1T1G S-MBT4413DW1T1G	K13	3000/Tape&Reel
MBT4413DW1T3G S-MBT4413DW1T3G	K13	10000/Tape&Reel

MAXIMUM RATINGS – NPN

Rating	Symbol	Value	Unit
Collector–Emitter Voltage	V_{CEO}	40	Vdc
Collector–Base Voltage	V_{CBO}	60	Vdc
Emitter–Base Voltage	V_{EBO}	6.0	Vdc
Collector Current — Continuous	I_C	600	mAdc

MAXIMUM RATINGS – PNP

Rating	Symbol	Value	Unit
Collector–Emitter Voltage	V_{CEO}	-40	Vdc
Collector–Base Voltage	V_{CBO}	-60	Vdc
Emitter–Base Voltage	V_{EBO}	-5.0	Vdc
Collector Current — Continuous	I_C	-600	mAdc

THERMAL CHARACTERISTICS

Characteristic	Symbol	Max	Unit
Total Device Dissipation FR– 5 Board, (1) $T_A = 25^\circ\text{C}$	P_D	225	mW
Derate above 25°C		1.8	mW/ $^\circ\text{C}$
Thermal Resistance, Junction to Ambient	$R_{\theta JA}$	556	$^\circ\text{C}/\text{W}$
Total Device Dissipation Alumina Substrate, (2) $T_A = 25^\circ\text{C}$	P_D	300	mW
Derate above 25°C		2.4	mW/ $^\circ\text{C}$
Thermal Resistance, Junction to Ambient	$R_{\theta JA}$	417	$^\circ\text{C}/\text{W}$
Junction and Storage Temperature	T_J, T_{stg}	-55 to +150	$^\circ\text{C}$

1. FR–5 = 1.0 x 0.75 x 0.062 in.

2. Alumina = 0.4 x 0.3 x 0.024 in. 99.5% alumina.

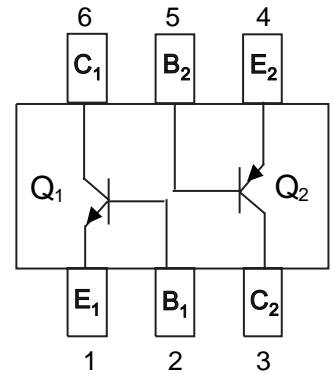
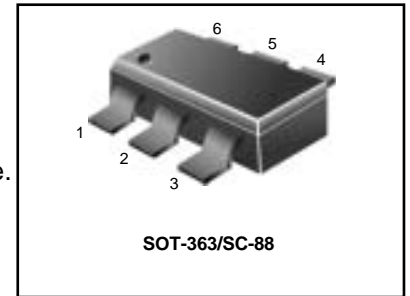

ELECTRICAL CHARACTERISTICS ($T_A = 25^\circ\text{C}$ unless otherwise noted.)

Characteristic	Symbol	Min	Max	Unit
----------------	--------	-----	-----	------

Q1(NPN) OFF CHARACTERISTICS

Collector–Emitter Breakdown Voltage (3) ($I_C = 1.0\text{ mA}$, $I_B = 0$)	$V_{(BR)CEO}$	40	—	Vdc
Collector–Base Breakdown Voltage ($I_C = 0.1\text{ mA}$, $I_E = 0$)	$V_{(BR)CBO}$	60	—	Vdc
Emitter–Base Breakdown Voltage ($I_E = 0.1\text{ mA}$, $I_C = 0$)	$V_{(BR)EBO}$	6.0	—	Vdc
Base Cutoff Current ($V_{CE} = 35\text{ Vdc}$, $V_{EB} = 0.4\text{ Vdc}$)	I_{BEV}	—	0.1	μA
Collector Cutoff Current ($V_{CE} = 35\text{ Vdc}$, $V_{EB} = 0.4\text{ Vdc}$)	I_{CEX}	—	0.1	μA

Q2(PNP) OFF CHARACTERISTICS

Collector–Emitter Breakdown Voltage (3) ($I_C = -1.0\text{ mA}$, $I_B = 0$)	$V_{(BR)CEO}$	-40	—	Vdc
Collector–Base Breakdown Voltage ($I_C = -0.1\text{ mA}$, $I_E = 0$)	$V_{(BR)CBO}$	-60	—	Vdc
Emitter–Base Breakdown Voltage ($I_E = -0.1\text{ mA}$, $I_C = 0$)	$V_{(BR)EBO}$	-5.0	—	Vdc
Base Cutoff Current ($V_{CE} = -35\text{ Vdc}$, $V_{EB} = -0.4\text{ Vdc}$)	I_{BEV}	—	-0.1	μA
Collector Cutoff Current ($V_{CE} = -35\text{ Vdc}$, $V_{EB} = -0.4\text{ Vdc}$)	I_{CEX}	—	-0.1	μA

- FR–5 = 1.0 x 0.75 x 0.062 in.
- Alumina = 0.4 x 0.3 x 0.024 in. 99.5% alumina.
- Pulse Test: Pulse Width $\leq 300\ \mu\text{s}$; Duty Cycle $\leq 2.0\%$.

Q1(NPN) ELECTRICAL CHARACTERISTICS ($T_A = 25^\circ\text{C}$ unless otherwise noted)

Characteristic	Symbol	Min	Max	Unit
----------------	--------	-----	-----	------

ON CHARACTERISTICS (3)

DC Current Gain ($I_C = 0.1 \text{ mA}$, $V_{CE} = 1.0 \text{ Vdc}$)	h_{FE}	20	—	—
($I_C = 1.0 \text{ mA}$, $V_{CE} = 1.0 \text{ Vdc}$)		40	—	
($I_C = 10 \text{ mA}$, $V_{CE} = 1.0 \text{ Vdc}$)		80	—	
($I_C = 150 \text{ mA}$, $V_{CE} = 1.0 \text{ Vdc}$)		100	300	
($I_C = 500 \text{ mA}$, $V_{CE} = 2.0 \text{ Vdc}$)		40	—	
Collector–Emitter Saturation Voltage ($I_C = 150 \text{ mA}$, $I_B = 15 \text{ mA}$)	$V_{CE(sat)}$	—	0.4	Vdc
($I_C = 500 \text{ mA}$, $I_B = 50 \text{ mA}$)		—	0.75	
Base–Emitter Saturation Voltage ($I_C = 150 \text{ mA}$, $I_B = 15 \text{ mA}$)	$V_{BE(sat)}$	0.75	0.95	Vdc
($I_C = 500 \text{ mA}$, $I_B = 50 \text{ mA}$)		—	1.2	

SMALL–SIGNAL CHARACTERISTICS

Current–Gain — Bandwidth Product ($I_C = 20 \text{ mA}$, $V_{CE} = 10 \text{ Vdc}$, $f = 100 \text{ MHz}$)	f_T	250	—	MHz
Collector–Base Capacitance ($V_{CB} = 5.0 \text{ Vdc}$, $I_E = 0$, $f = 1.0 \text{ MHz}$)	C_{cb}	—	6.5	pF
Emitter–Base Capacitance ($V_{EB} = 0.5 \text{ Vdc}$, $I_C = 0$, $f = 1.0 \text{ MHz}$)	C_{eb}	—	30	pF
Input Impedance ($V_{CE} = 10 \text{ Vdc}$, $I_C = 1.0 \text{ mA}$, $f = 1.0 \text{ kHz}$)	h_{ie}	1.0	15	k Ω
Voltage Feedback Ratio ($V_{CE} = 10 \text{ Vdc}$, $I_C = 1.0 \text{ mA}$, $f = 1.0 \text{ kHz}$)	h_{re}	0.1	8.0	$\times 10^{-4}$
Small–Signal Current Gain ($V_{CE} = 10 \text{ Vdc}$, $I_C = 1.0 \text{ mA}$, $f = 1.0 \text{ kHz}$)	h_{fe}	40	500	—
Output Admittance ($V_{CE} = 10 \text{ Vdc}$, $I_C = 1.0 \text{ mA}$, $f = 1.0 \text{ kHz}$)	h_{oe}	1.0	30	μmhos

SWITCHING CHARACTERISTICS

Delay Time	($V_{CC} = 30 \text{ Vdc}$, $V_{EB} = 2.0 \text{ Vdc}$ $I_C = 150 \text{ mA}$, $I_{B1} = 15 \text{ mA}$)	t_d	—	15	ns
Rise Time		t_r	—	20	
Storage Time	($V_{CC} = 30 \text{ Vdc}$, $I_C = 150 \text{ mA}$ $I_{B1} = I_{B2} = 15 \text{ mA}$)	t_s	—	225	ns
Fall Time		t_f	—	30	

3. Pulse Test: Pulse Width $\leq 300 \mu\text{s}$; Duty Cycle $\leq 2.0\%$.

SWITCHING TIME EQUIVALENT TEST CIRCUITS (Q1 NPN)

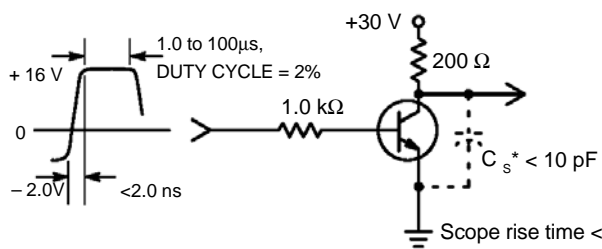

Figure 1. Turn–On Time

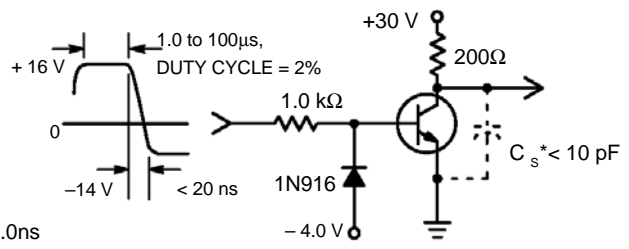

Figure 2. Turn–Off Time

Q2(PNP) ELECTRICAL CHARACTERISTICS (T_A = 25°C unless otherwise noted)

Characteristic	Symbol	Min	Max	Unit
----------------	--------	-----	-----	------

ON CHARACTERISTICS

DC Current Gain (I _C = -0.1 mA, V _{CE} = -1.0 Vdc)	h _{FE}	30	—	—
(I _C = -1.0 mA, V _{CE} = -1.0 Vdc)		60	—	
(I _C = -10 mA, V _{CE} = -1.0 Vdc)		100	—	
(I _C = -150 mA, V _{CE} = -2.0 Vdc)(3)		100	300	
(I _C = -500 mA, V _{CE} = -2.0 Vdc)(3)		20	—	
Collector-Emitter Saturation Voltage(3) (I _C = -150mA, I _B = -15 mA)	V _{CE(sat)}	—	-0.4	Vdc
(I _C = -500 mA, I _B = -50 mA)		—	-0.75	
Base-Emitter Saturation Voltage (3) (I _C = -150 mA, I _B = -15 mA)	V _{BE(sat)}	-0.75	-0.95	Vdc
(I _C = -500 mA, I _B = -50 mA)		—	-1.3	

SMALL-SIGNAL CHARACTERISTICS

Current-Gain — Bandwidth Product (I _C = -20mA, V _{CE} = -10 Vdc, f = 100 MHz)	f _T	200	—	MHz
Collector-Base Capacitance (V _{CB} = -10 Vdc, I _E = 0, f = 1.0 MHz)	C _{cb}	—	8.5	pF
Emitter-Base Capacitance (V _{BE} = -0.5 Vdc, I _C = 0, f = 1.0 MHz)	C _{eb}	—	30	pF
Input Impedance (V _{CE} = -10 Vdc, I _C = -1.0 mA, f = 1.0 kHz)	h _{ie}	1.5	15	kΩ
Voltage Feedback Ratio (V _{CE} = -10 Vdc, I _C = -1.0 mA, f = 1.0 kHz)	h _{re}	0.1	8.0	X 10 ⁻⁴
Small-Signal Current Gain (V _{CE} = -10 Vdc, I _C = -1.0 mA, f = 1.0 kHz)	h _{fe}	60	500	—
Output Admittance (V _{CE} = -10 Vdc, I _C = -1.0 mA, f = 1.0 kHz)	h _{oe}	1.0	100	μmhos

SWITCHING CHARACTERISTICS

Delay Time	(V _{CC} = -30 Vdc, V _{EB} = -2.0 Vdc,	t _d	—	15	ns
Rise Time	I _C = -150mA, I _{B1} = -15 mA)	t _d	—	20	
Storage Time	(V _{CC} = -30 Vdc, I _C = -150 mA,	t _s	—	225	ns
Fall Time	I _{B1} = I _{B2} = -15 mA)	t _f	—	30	

3. Pulse Test: Pulse Width ≤ 300 μs; Duty Cycle ≤ 2.0%.

SWITCHING TIME EQUIVALENT TEST CIRCUITS (Q2 PNP)

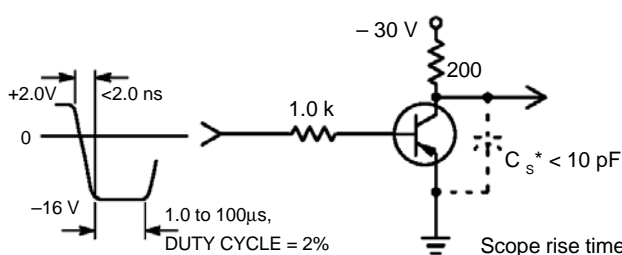

Figure 3. Turn-On Time

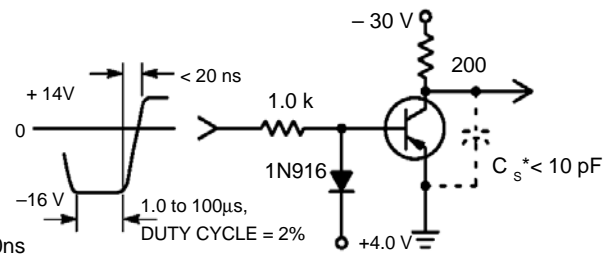

Figure 4. Turn-Off Time

*Total shunt capacitance of test jig connectors, and oscilloscope

TRANSIENT CHARACTERISTICS (Q1 NPN)

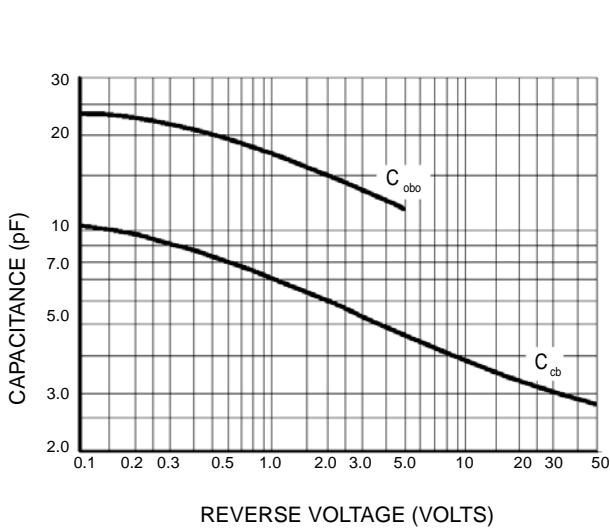

Figure 5. Capacitance

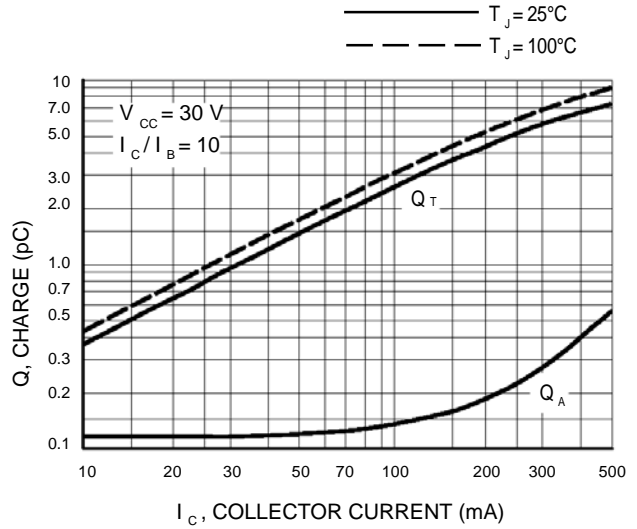

Figure 6. Charge Data

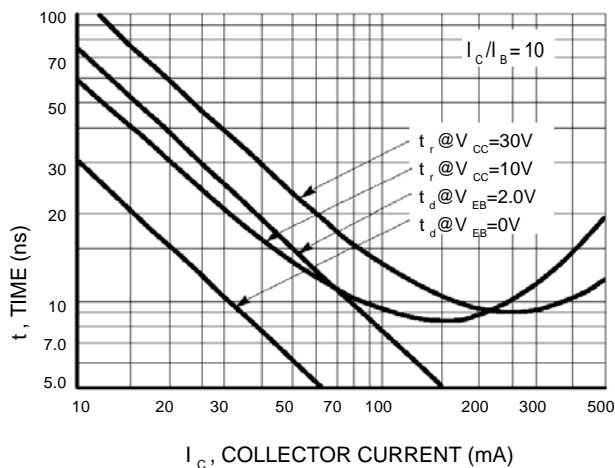

Figure 7. Turn-On Time

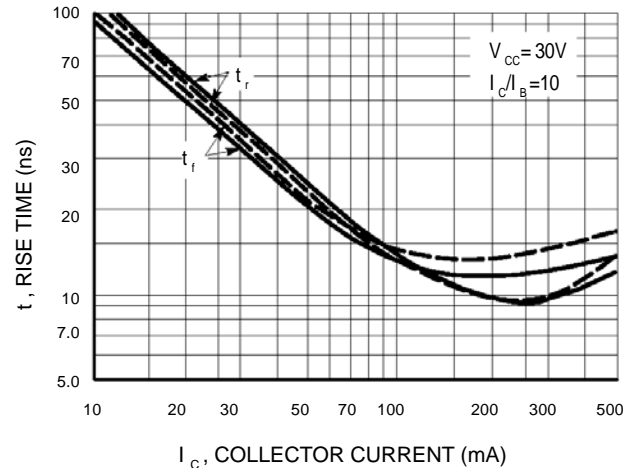

Figure 8. Rise and Fall Time

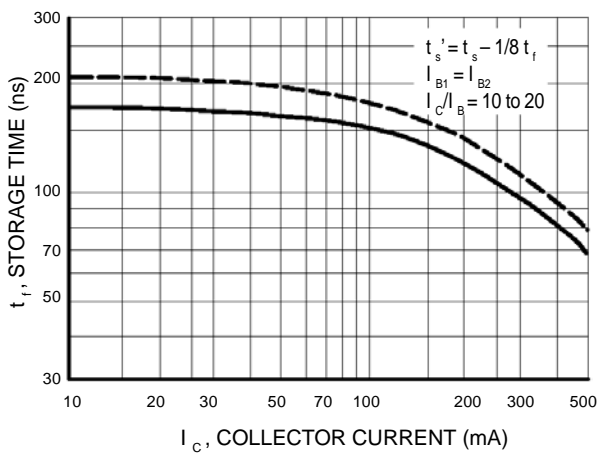

Figure 9. Storage Time

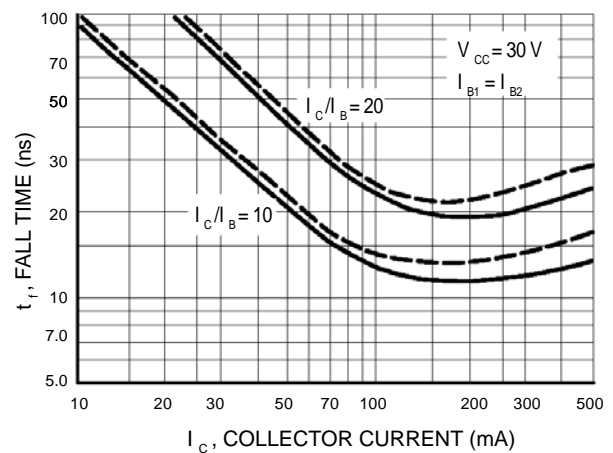

Figure 10. Fall Time

SMALL-SIGNAL CHARACTERISTICS(Q1 NPN)

NOISE FIGURE

$V_{CE} = 10 \text{ Vdc}$, $T_A = 25^\circ\text{C}$
Bandwidth = 1.0 Hz

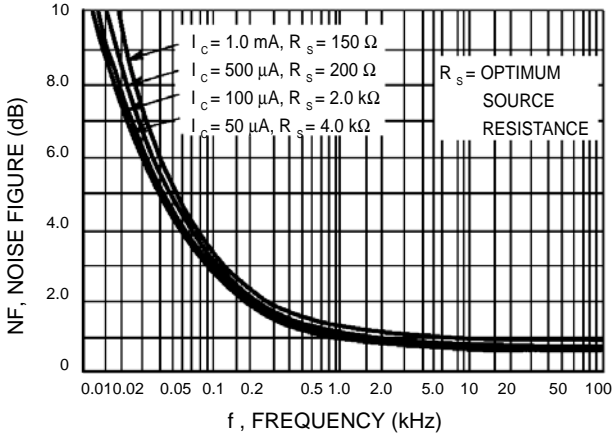

Figure 11. Frequency Effects

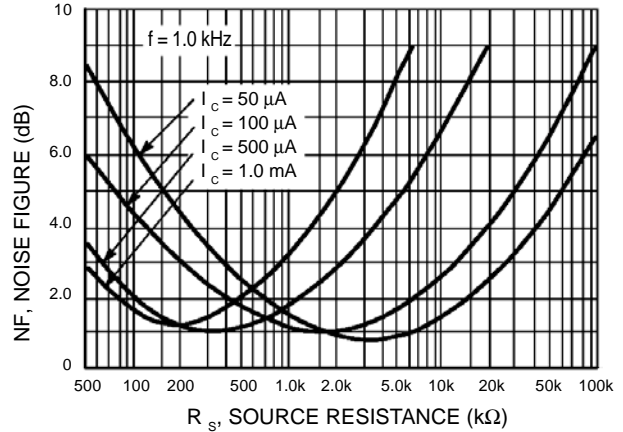

Figure 12. Source Resistance Effects

h PARAMETERS

$(V_{CE} = 10 \text{ Vdc}$, $f = 1.0 \text{ kHz}$, $T_A = 25^\circ\text{C}$)

This group of graphs illustrates the relationship between h_{fe} and other "h" parameters for this series of transistors. To obtain these curves, a high-gain and a low-gain unit were selected from the LMBT4413DW1T1G lines, and the same units were used to develop the correspondingly numbered curves on each graph.

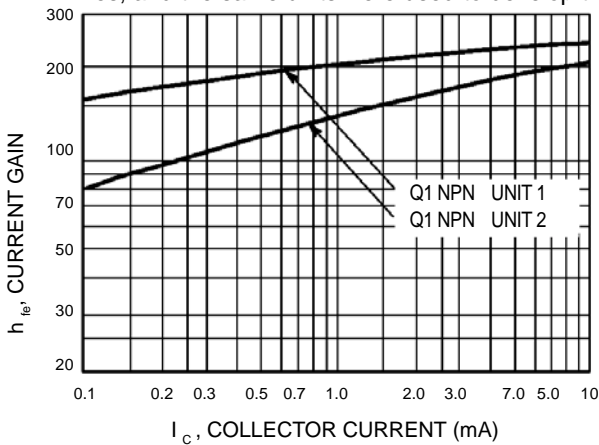

Figure 13. Current Gain

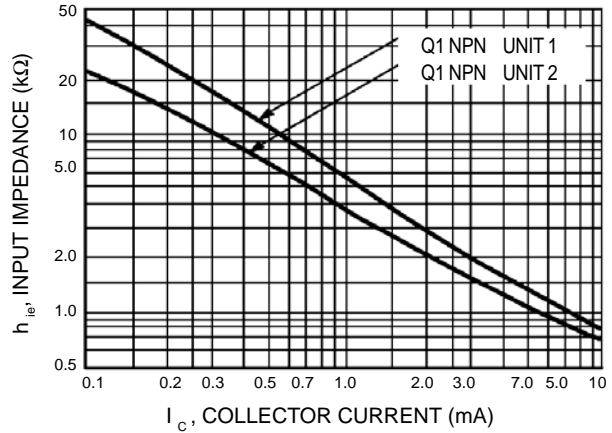

Figure 14. Input Impedance

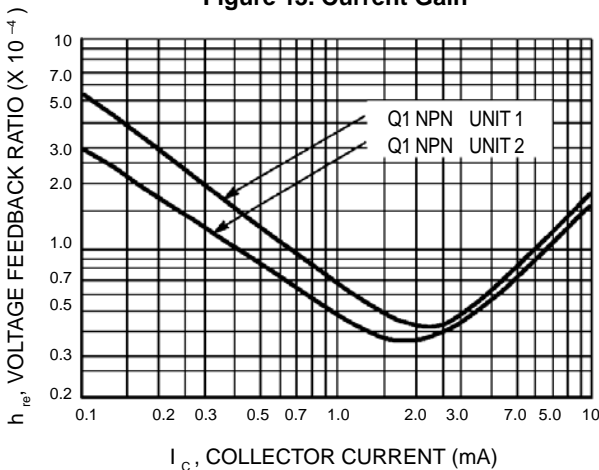

Figure 15. Voltage Feedback Ratio

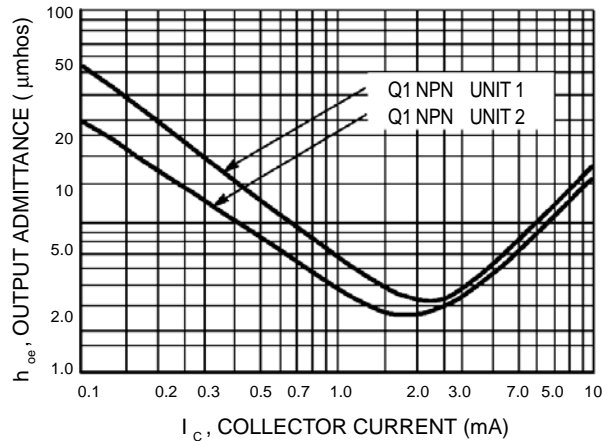

Figure 16. Output Admittance

STATIC CHARACTERISTICS (Q1 NPN)

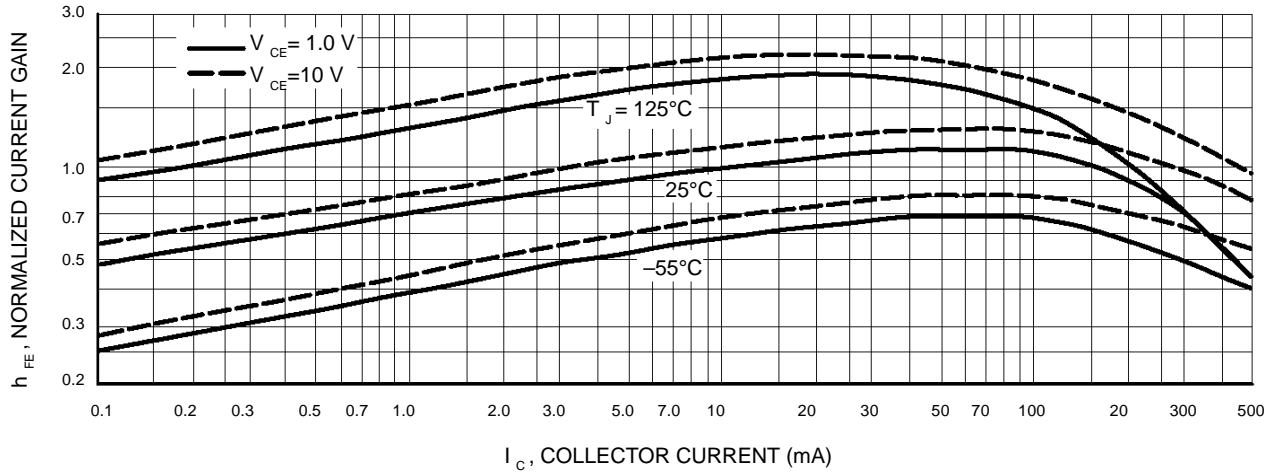

Figure 17. DC Current Gain

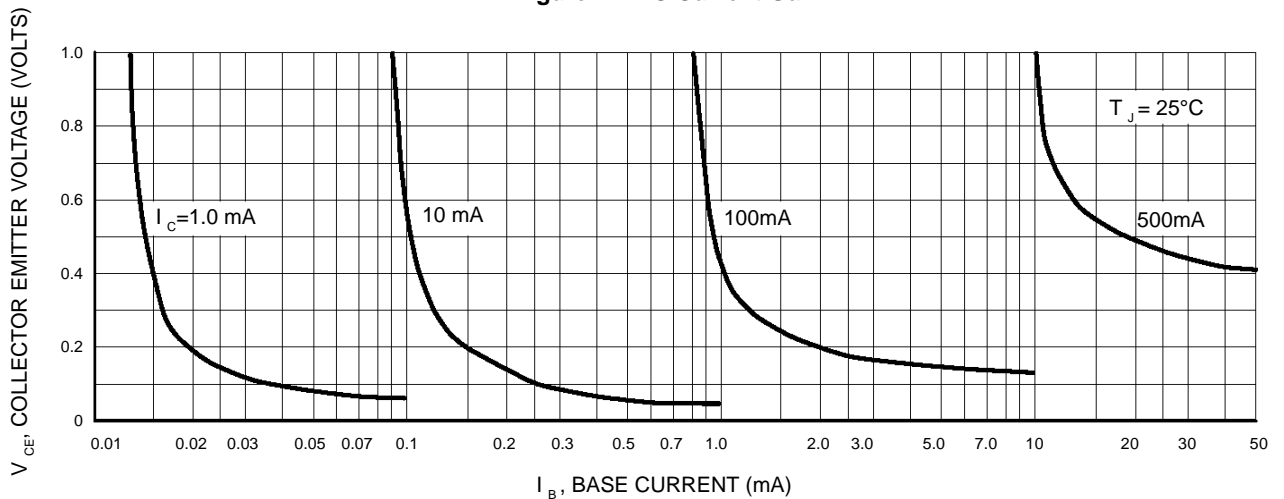

Figure 18. Collector Saturation Region

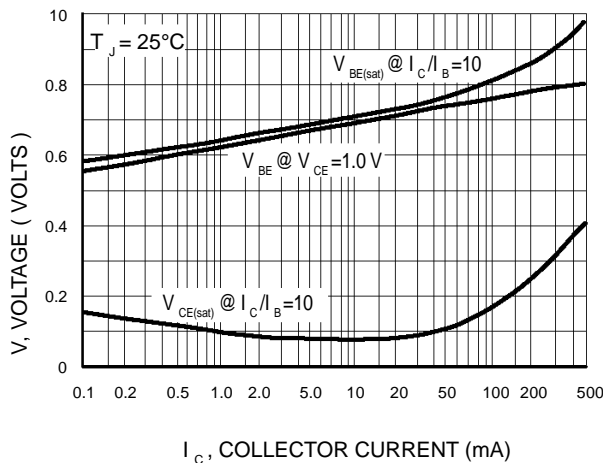

Figure 19. "On" Voltages

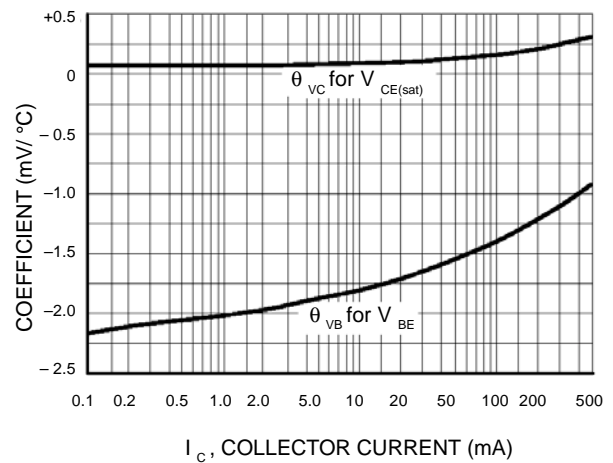

Figure 20. Temperature Coefficients

TYPICAL TRANSIENT CHARACTERISTICS (Q2 PNP)

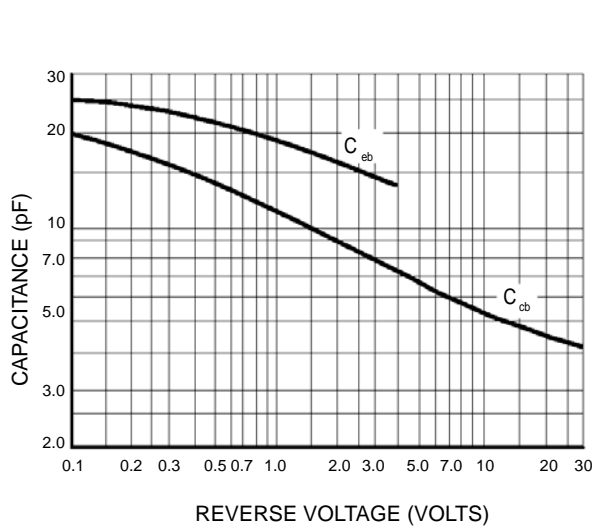

Figure 3. Capacitance

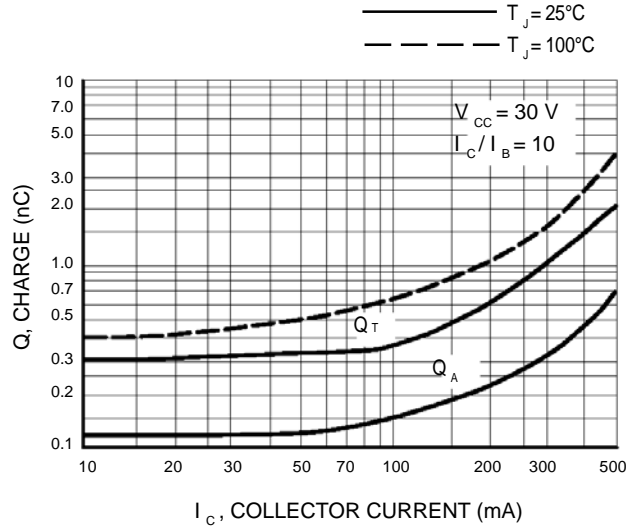

Figure 4. Charge Data

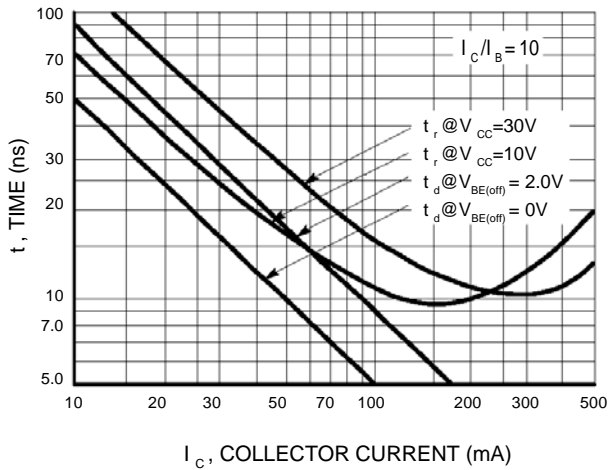

Figure 5. Turn-On Time

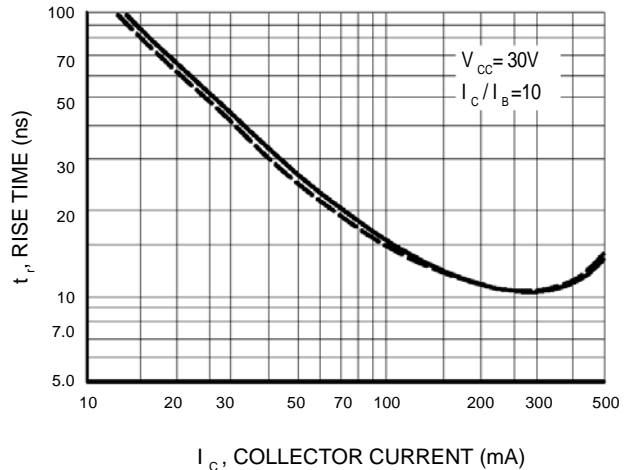

Figure 6. Rise Time

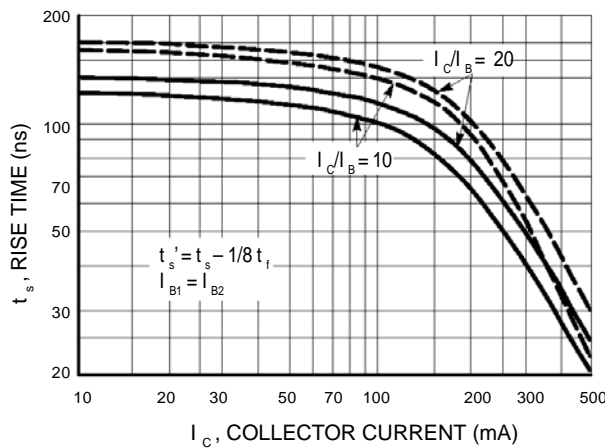

Figure 7. Storage Time

SMALL-SIGNAL CHARACTERISTICS (Q2 PNP)

NOISE FIGURE

$V_{CE} = -10 \text{ Vdc}$, $T_A = 25^\circ\text{C}$
 Bandwidth = 1.0 Hz

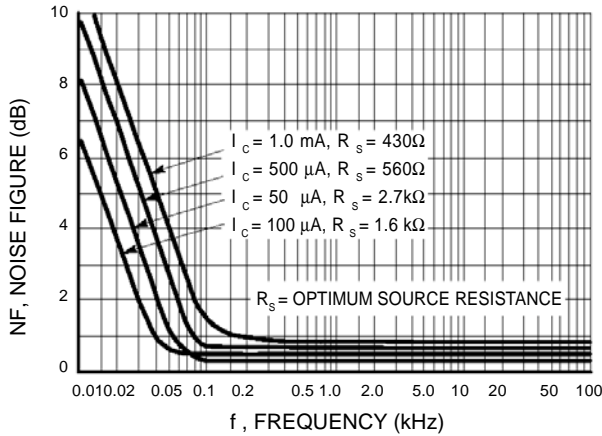

Figure 8. Frequency Effects

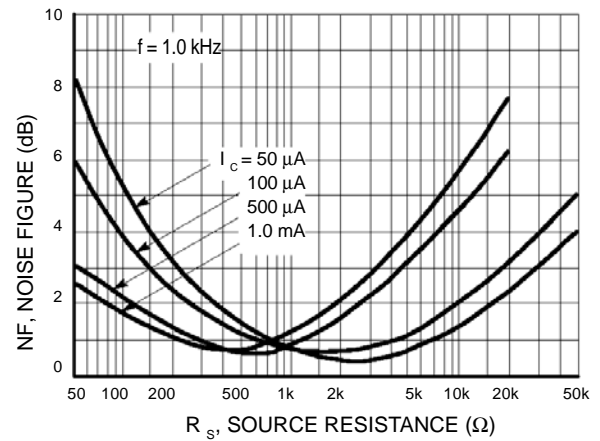

Figure 9. Source Resistance Effects

h PARAMETERS

$(V_{CE} = -10 \text{ Vdc}$, $f = 1.0 \text{ kHz}$, $T_A = 25^\circ\text{C}$)

This group of graphs illustrates the relationship between h_{fe} and other "h" parameters for this series of transistors. To obtain these curves, a high-gain and a low-gain unit were selected from the LMBT4413DW1T1G lines, and the same units were used to develop the correspondingly numbered curves on each graph.

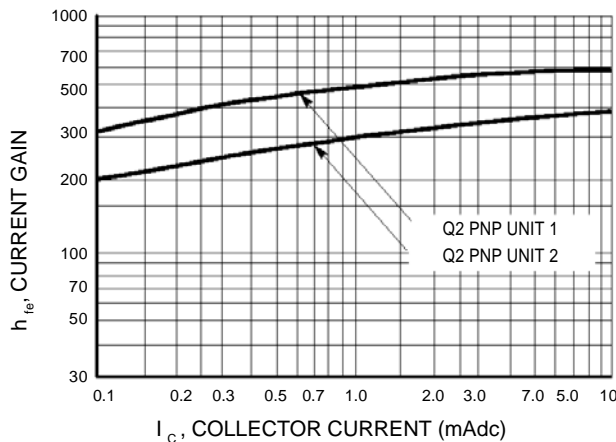

Figure 10. Current Gain

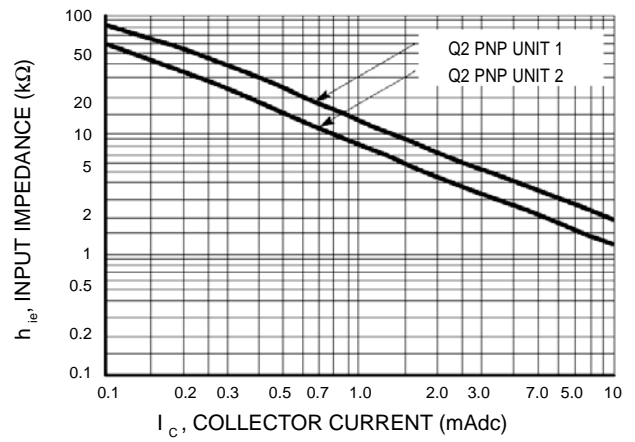

Figure 11. Input Impedance

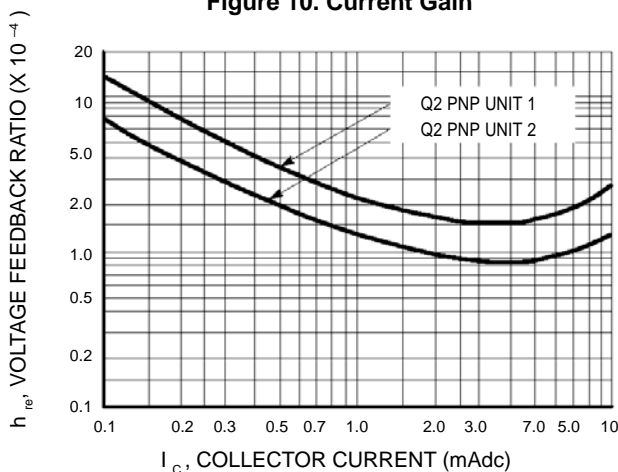

Figure 12. Voltage Feedback Ratio

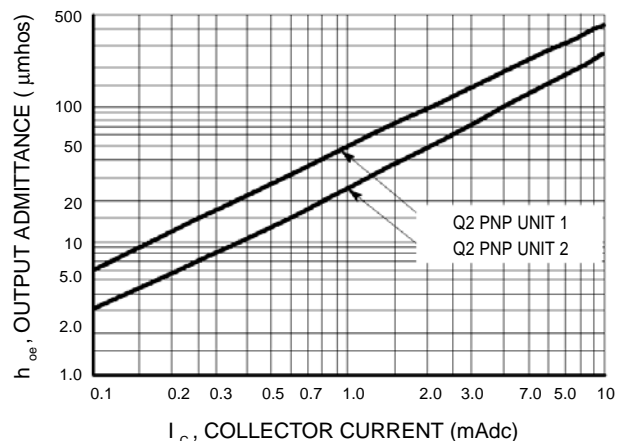

Figure 13. Output Admittance

STATIC CHARACTERISTICS (Q2 PNP)

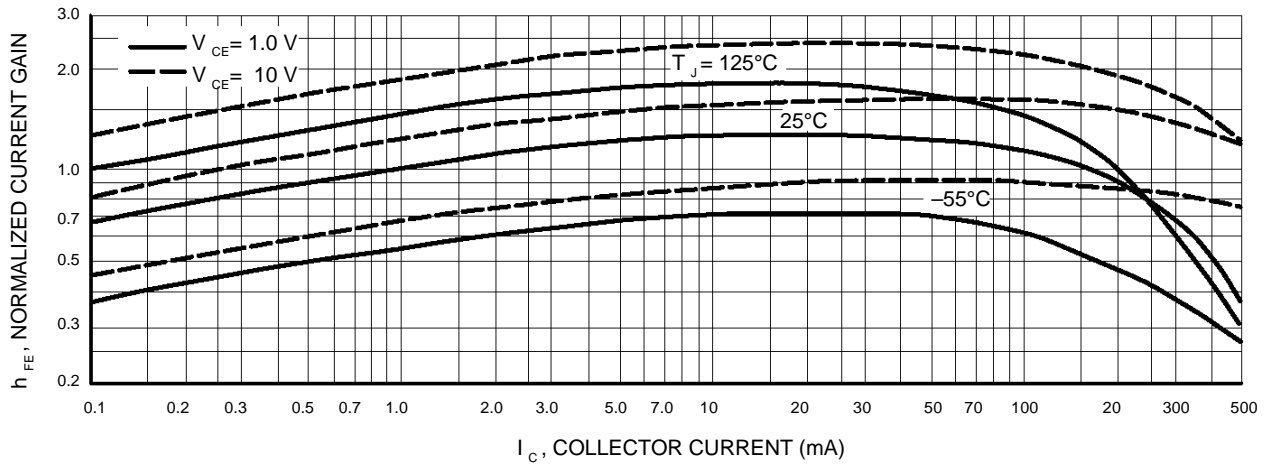

Figure 14. DC Current Gain

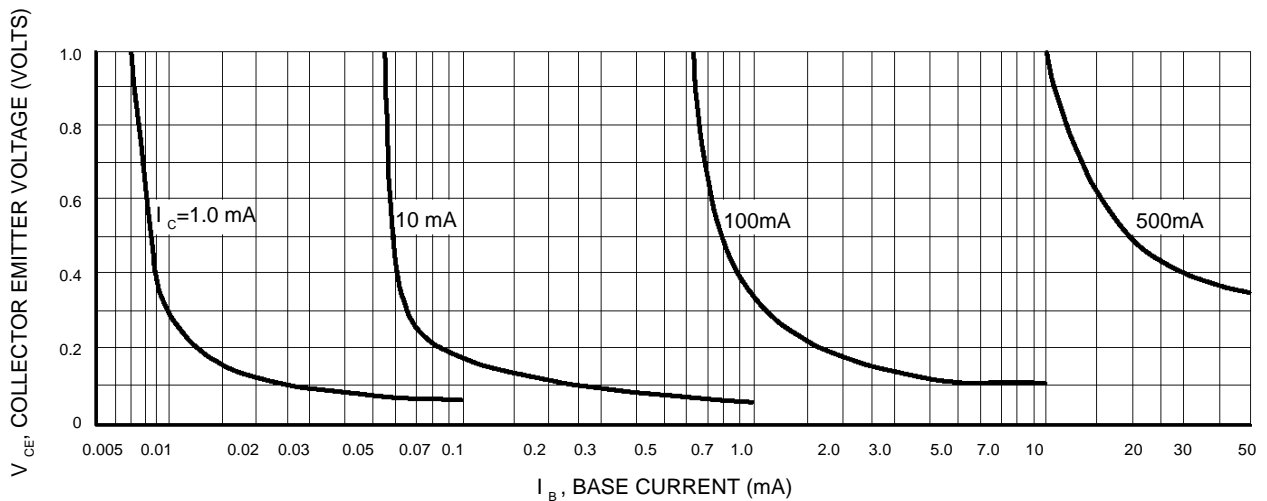

Figure 15. Collector Saturation Region

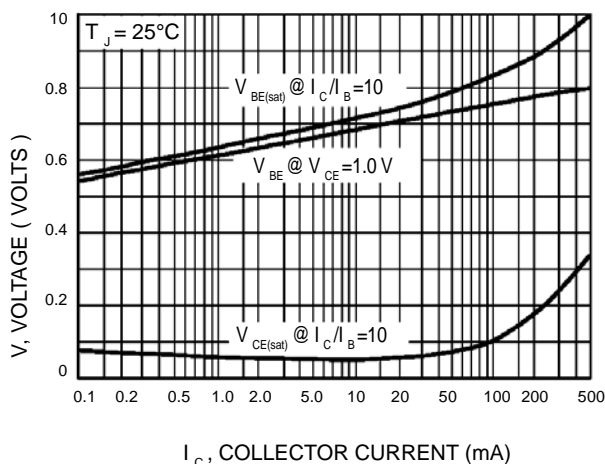

Figure 16. "On" Voltages

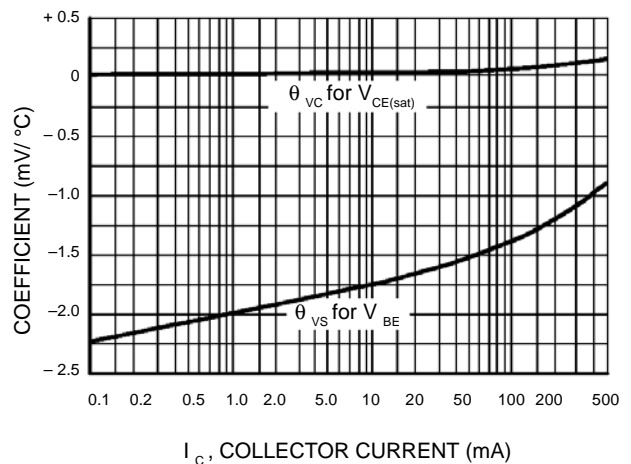
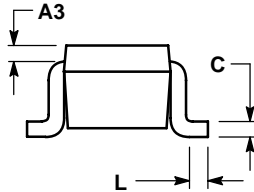
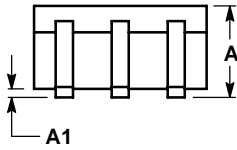
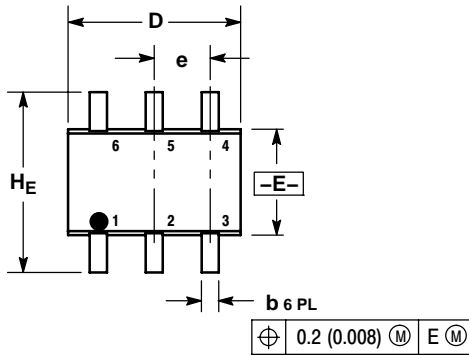

Figure 17. Temperature Coefficients

DUAL SMALL SIGNAL SURFACE MOUNT TRANSISTOR MBT4413DW1T1G, S-MBT4413DW1T1G

SC-88



NOTES:

1. DIMENSIONING AND TOLERANCING PER ANSI Y14.5M, 1982.
2. CONTROLLING DIMENSION: INCH.
3. 419B-01 OBSOLETE, NEW STANDARD 419B-02.

DIM	MILLIMETERS			INCHES		
	MIN	NOM	MAX	MIN	NOM	MAX
A	0.80	0.95	1.10	0.031	0.037	0.043
A1	0.00	0.05	0.10	0.000	0.002	0.004
A3	0.20 REF			0.008 REF		
b	0.10	0.21	0.30	0.004	0.008	0.012
C	0.10	0.14	0.25	0.004	0.005	0.010
D	1.80	2.00	2.20	0.070	0.078	0.086
E	1.15	1.25	1.35	0.045	0.049	0.053
e	0.65 BSC			0.026 BSC		
L	0.10	0.20	0.30	0.004	0.008	0.012
HE	2.00	2.10	2.20	0.078	0.082	0.086

**GENERIC
 MARKING DIAGRAM***

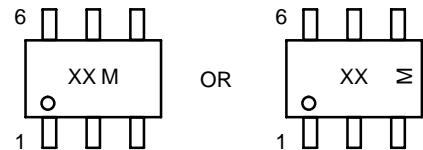

XX = Specific Device Code
 M = Date Code