

### 1. FEATURES

- We declare that the material of product compliance with RoHS requirements and Halogen Free.
- S- prefix for automotive and other applications requiring unique site and control change requirements; AEC-Q101 qualified and PPAP capable.

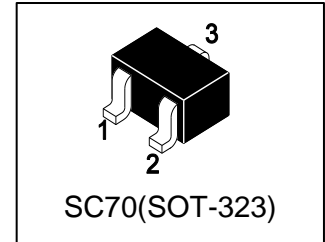

### 2. DEVICE MARKING AND ORDERING INFORMATION

Device	Marking	Shipping
MBT3906WT1G	2A	3000/Tape&Reel
MBT3906WT3G	2A	10000/Tape&Reel

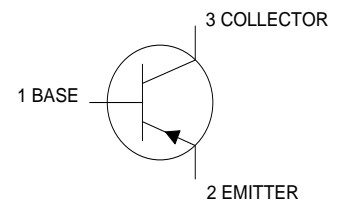

### 3. MAXIMUM RATINGS(Ta = 25°C)

Parameter	Symbol	Limits	Unit
Collector–Emitter Voltage	V <sub>CEO</sub>	-40	V <sub>dc</sub>
Collector–Base Voltage	V <sub>CBO</sub>	-40	V <sub>dc</sub>
Emitter–Base Voltage	V <sub>EBO</sub>	-5	V <sub>dc</sub>
Collector Current — Continuous	I <sub>C</sub>	-200	mA <sub>dc</sub>

### 4. THERMAL CHARACTERISTICS

Parameter	Symbol	Limits	Unit
Total Device Dissipation, FR-5 Board (Note 1) @ TA = 25°C Derate above 25°C	PD	150 1.2	mW mW/°C
Thermal Resistance, Junction–to–Ambient(Note 1)	R <sub>θJA</sub>	833	°C/W
Junction and Storage temperature	T <sub>J</sub> ,T <sub>stg</sub>	-55~+150	°C

1. FR-5 = 1.0×0.75×0.062 in.

### 5. ELECTRICAL CHARACTERISTICS (Ta= 25°C)

#### OFF CHARACTERISTICS

Characteristic	Symbol	Min.	Typ.	Max.	Unit
Collector–Emitter Breakdown Voltage (IC = -1.0 mAdc, IB = 0)	VBR(CEO)	-40	-	-	V
Collector–Base Breakdown Voltage (IC = -10 µAdc, IE = 0)	VBR(CBO)	-40	-	-	V
Emitter–Base Breakdown Voltage (IE = -10 µAdc, IC = 0)	VBR(EBO)	-5	-	-	V
Collector Cutoff Current ( VCE = -30 Vdc, VEB = -3.0Vdc)	ICEX	-	-	-50	nA
Base Cutoff Current (VCE = -30 Vdc, VEB = -3.0Vdc)	IBL	-	-	-50	nA

#### ON CHARACTERISTICS (Note 2.)

DC Current Gain (IC = -0.1 mAdc, VCE = -1.0 Vdc)	HFE	60	-	-	V
(IC = -1.0 mAdc, VCE = -1.0 Vdc)		80	-	-	
(IC = -10 mAdc, VCE = -1.0 Vdc)		100	-	300	
(IC = -50 mAdc, VCE = -1.0 Vdc)		60	-	-	
(IC = -100 mAdc, VCE = -1.0 Vdc)		30	-	-	
Collector–Emitter Saturation Voltage (IC = -10 mAdc, IB = -1.0 mAdc)	VCE(sat)	-	-	-0.25	V
(IC = -50 mAdc, IB = -5.0 mAdc)		-	-	-0.4	
Base–Emitter Saturation Voltage (IC = -10 mAdc, IB = -1.0 mAdc)	VBE(sat)	-0.65	-	-0.85	V
(IC = -50 mAdc, IB = -5.0 mAdc)		-	-	-0.95	

#### SMALL–SIGNAL CHARACTERISTICS

Current–Gain — Bandwidth Product (IC = -10mAdc, VCE= -20Vdc, f = 100MHz)	fT	250	-	-	MHz
Output Capacitance (VCB = -5.0 Vdc, IE = 0, f = 1.0 MHz)	Cobo	-	-	4.5	pF
Input Capacitance (VEB = -0.5 Vdc, IC = 0, f = 1.0 MHz)	Cibo	-	-	10	pF

#### SWITCHING CHARACTERISTICS

Delay Time	(VCC = -3.0 Vdc, VBE=0.5Vdc, IC = -10mAdc, IB1 = -1.0 mAdc)	td	-	-	35	ns
Rise Time		tr	-	-	35	
Storage Time		ts	-	-	225	
Fall Time		tf	-	-	75	

2.Pulse Test: Pulse Width  $\leq 300 \mu s$ , Duty Cycle  $\leq 2.0\%$ .

**6. ELECTRICAL CHARACTERISTICS CURVES**

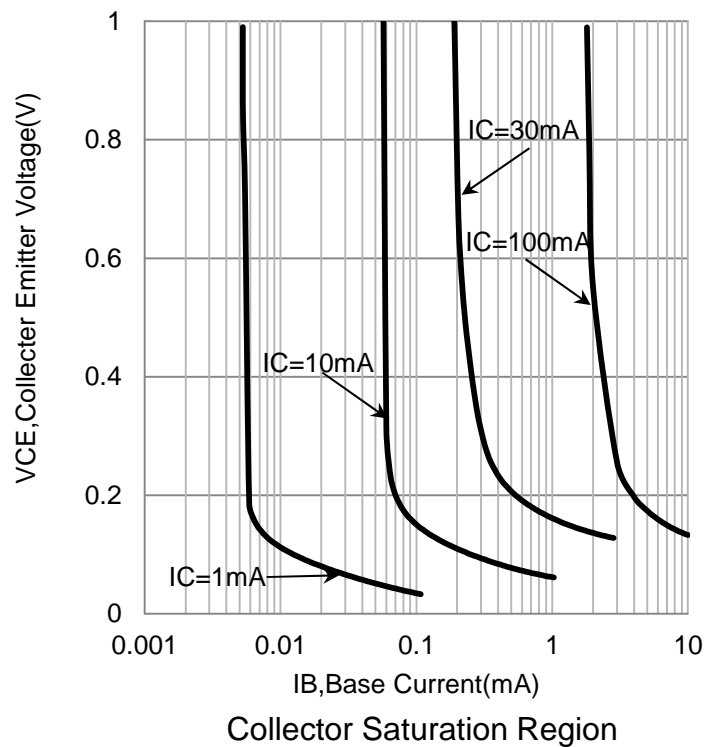
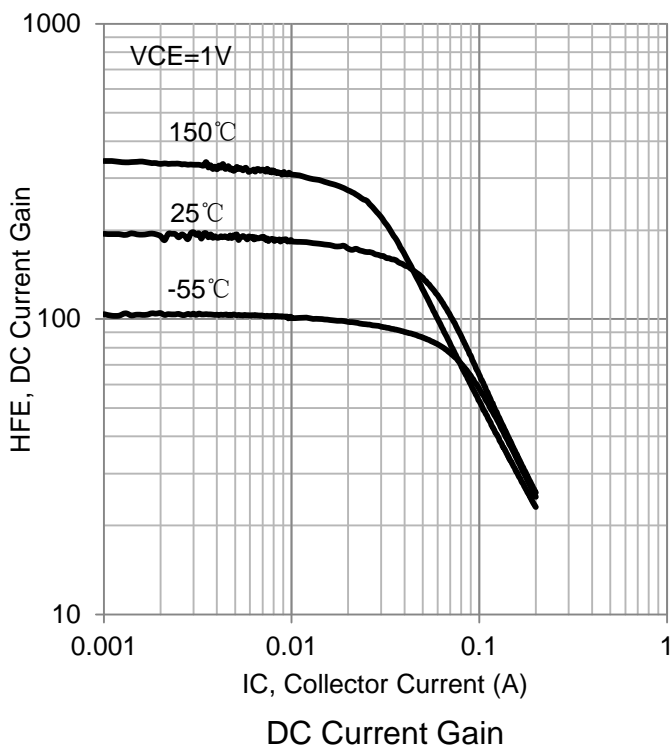
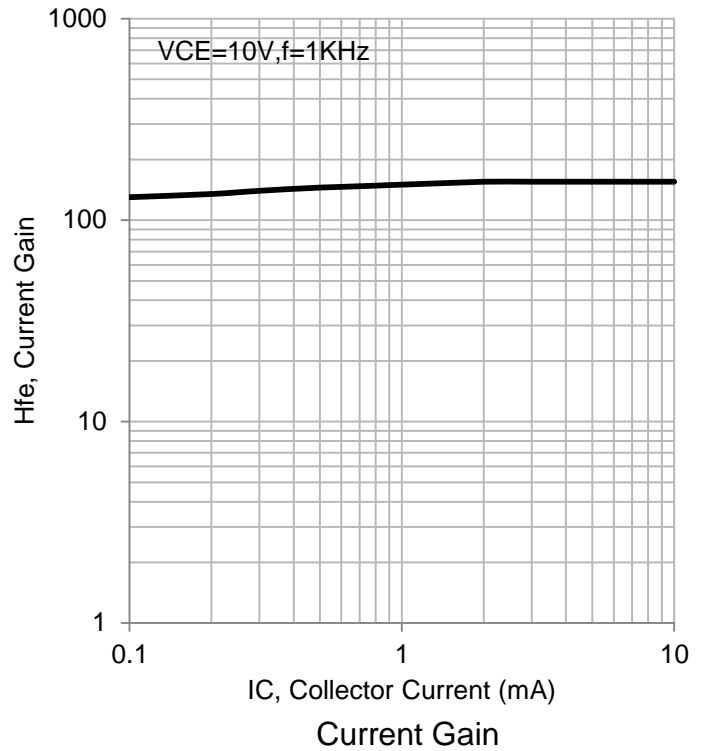
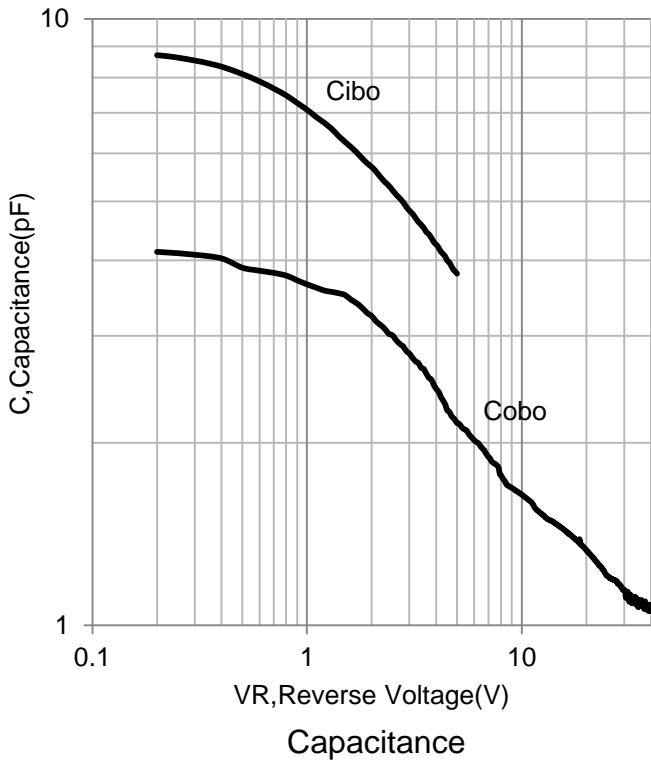

**6. ELECTRICAL CHARACTERISTICS CURVES(Con.)**

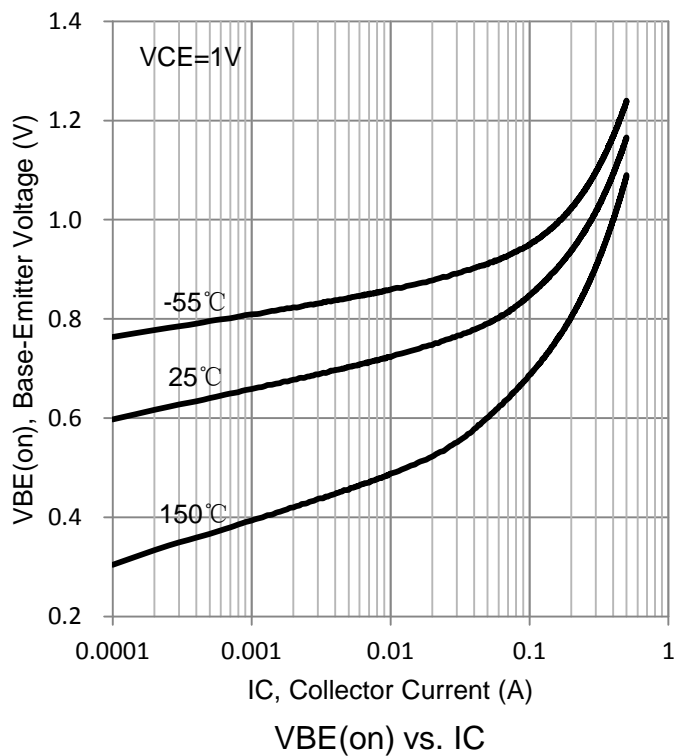
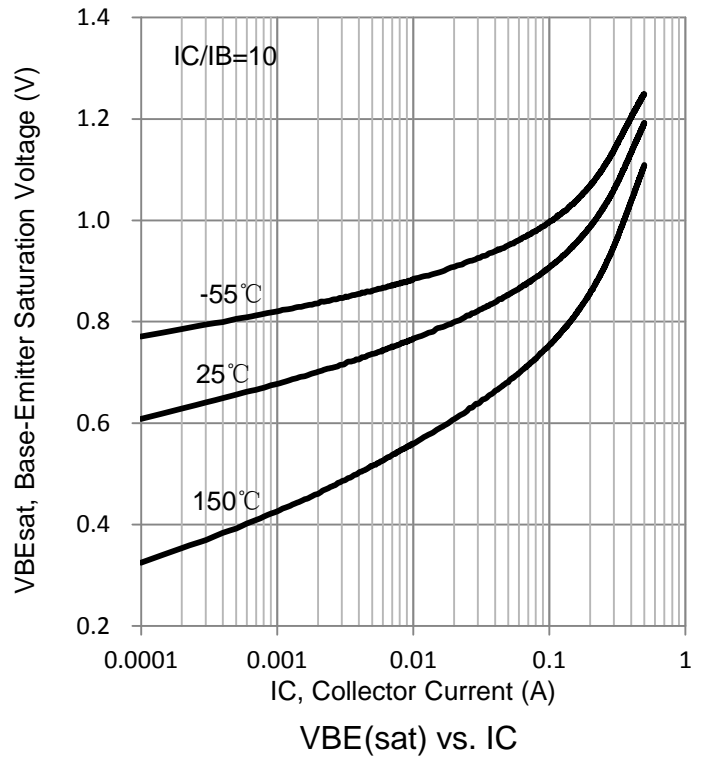
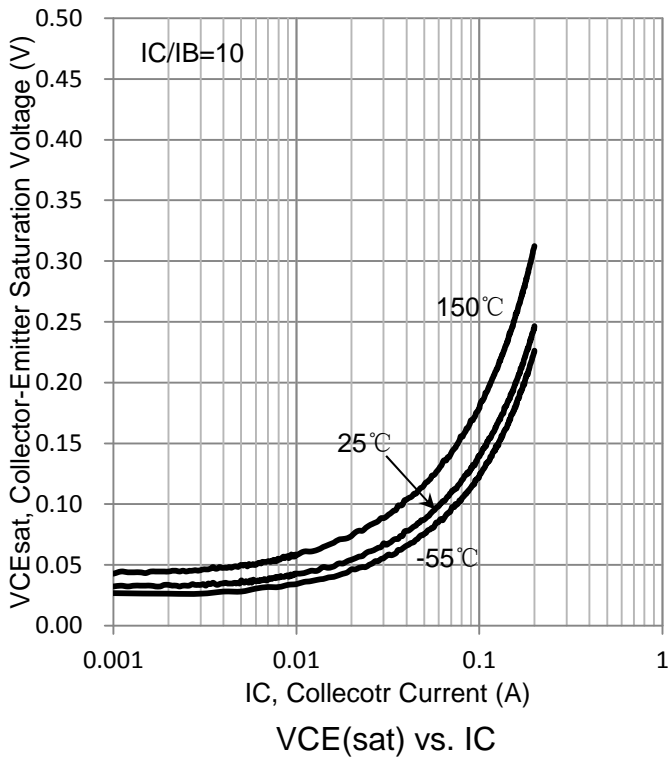

### 7.OUTLINE AND DIMENSIONS

Notes:

1. DIMENSIONING AND TOLERANCING PER ANSI Y14.5M, 1982.
2. CONTROLLING DIMENSION: MILLIMETERS.
3. MAXIMUM LEAD THICKNESS INCLUDES LEAD FINISH. MINIMUM LEAD THICKNESS IS THE MINIMUM THICKNESS OF BASE MATERIAL.
4. DIMENSIONS D AND E DO NOT INCLUDE MOLD FLASH, PROTRUSIONS OR GATE BURRS.

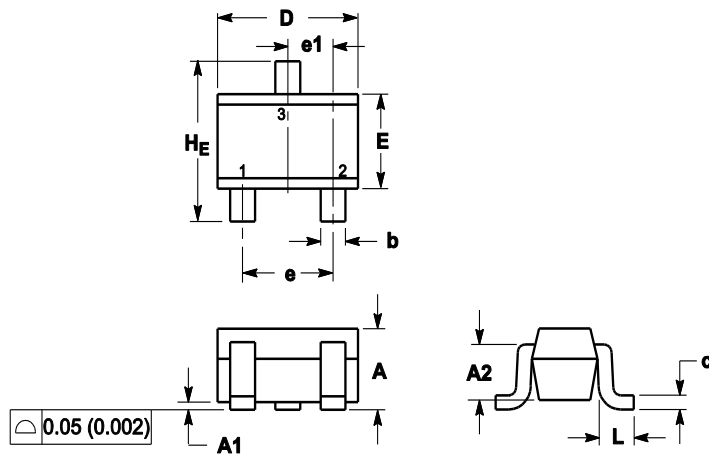

DIM	MILLIMETERS			INCHES		
	MIN	NOM	MAX	MIN	NOM	MAX
A	0.80	0.90	1.00	0.032	0.035	0.039
A1	0.00	0.05	0.10	0.000	0.002	0.004
A2	0.70REF			0.028REF		
b	0.30	0.35	0.40	0.012	0.014	0.016
c	0.10	0.18	0.25	0.004	0.007	0.010
D	1.80	2.10	2.20	0.071	0.083	0.087
E	1.15	1.24	1.35	0.045	0.049	0.053
e	1.20	1.30	1.40	0.047	0.051	0.055
e1	0.65REF			0.026REF		
L	0.20	0.38	0.56	0.008	0.015	0.022
HE	2.00	2.10	2.40	0.079	0.083	0.095

### 8.SOLDERING FOOTPRINT

