

1. FEATURES

- We declare that the material of product compliance with RoHS requirements and Halogen Free.
- S- prefix for automotive and other applications requiring unique site and control change requirements; AEC-Q101 qualified and PPAP capable.

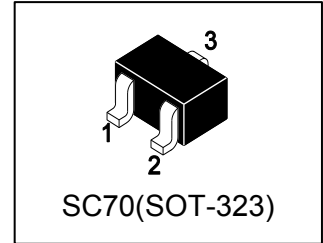

2. DEVICE MARKING AND ORDERING INFORMATION

Device	Marking	Shipping
MBT3904WT1G	AM	3000/Tape&Reel
MBT3904WT3G	AM	10000/Tape&Reel

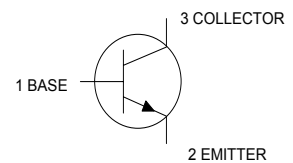

3. MAXIMUM RATINGS(Ta = 25°C)

Parameter	Symbol	Limits	Unit
Collector–Emitter Voltage	V _{CEO}	40	V
Collector–Base Voltage	V _{CBO}	60	V
Emitter–Base Voltage	V _{EBO}	6	V
Collector Current — Continuous	I _C	200	mA

4. THERMAL CHARACTERISTICS

Parameter	Symbol	Limits	Unit
Total Device Dissipation, FR-5 Board (Note 1) @ TA = 25°C Derate above 25°C	PD	150 1.2	mW mW/°C
Thermal Resistance, Junction–to–Ambient(Note 1)	R _{θJA}	833	°C/W
Junction and Storage temperature	T _J , T _{stg}	-55~+150	°C

1. FR-5 = 1.0×0.75×0.062 in.

5. ELECTRICAL CHARACTERISTICS (Ta= 25°C)

OFF CHARACTERISTICS

Characteristic	Symbol	Min.	Typ.	Max.	Unit
Collector–Emitter Breakdown Voltage (IC = 1.0 mA, IB = 0)	VBR(CEO)	40	-	-	V
Collector–Base Breakdown Voltage (IC = 10 μA, IE = 0)	VBR(CBO)	60	-	-	V
Emitter–Base Breakdown Voltage (IE = 10 μA, IC = 0)	VBR(EBO)	6	-	-	V
Collector Cutoff Current (VCE = 30 V, VEB = 3.0V)	ICEX	-	-	50	nA
Base Cutoff Current (VCE = 30 V, VEB = 3.0V)	IBL	-	-	50	nA

ON CHARACTERISTICS (Note 2.)

DC Current Gain (IC = 0.1 mA, VCE = 1.0 V) (IC = 1.0 mA, VCE = 1.0 V) (IC = 10 mA, VCE = 1.0 V) (IC = 50 mA, VCE = 1.0 V) (IC = 100 mA, VCE = 1.0 V)	HFE	40 70 100 60 30	- - - - -	- - 300 - -	
Collector–Emitter Saturation Voltage (IC = 10 mA, IB = 1.0 mA) (IC = 50 mA, IB = 5.0 mA)	VCE(sat)	- -	- -	0.2 0.3	V
Base–Emitter Saturation Voltage (IC = 10 mA, IB = 1.0 mA) (IC = 50 mA, IB = 5.0 mA)	VBE(sat)	0.65 -	- -	0.85 0.95	V

SMALL–SIGNAL CHARACTERISTICS

Current–Gain — Bandwidth Product (IC = 10mA, VCE= 20V, f = 100MHz)	fT	300	-	-	MHz
Output Capacitance (VCB = 5.0 V, IE = 0, f = 1.0 MHz)	Cobo	-	-	4	pF
Input Capacitance (VEB = 0.5 V, IC = 0, f = 1.0 MHz)	Cibo	-	-	8	pF

SWITCHING CHARACTERISTICS

Delay Time	(VCC = 3.0 V, VBE=-0.5V, IC = 10mA, IB1 = 1.0 mA)	td	-	-	35	ns
Rise Time		tr	-	-	35	
Storage Time	(VCC = 3.0 V, IC = 10 mA, IB1 = IB2 = 1.0 mA)	ts	-	-	200	
Fall Time		tf	-	-	50	

2.Pulse Test: Pulse Width ≤300 μs, Duty Cycle ≤2.0%.

6. ELECTRICAL CHARACTERISTICS CURVES

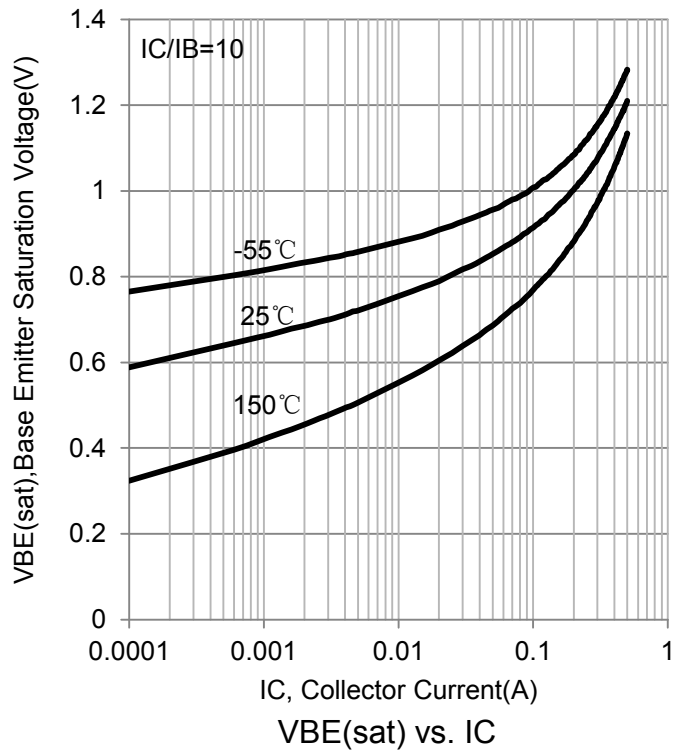
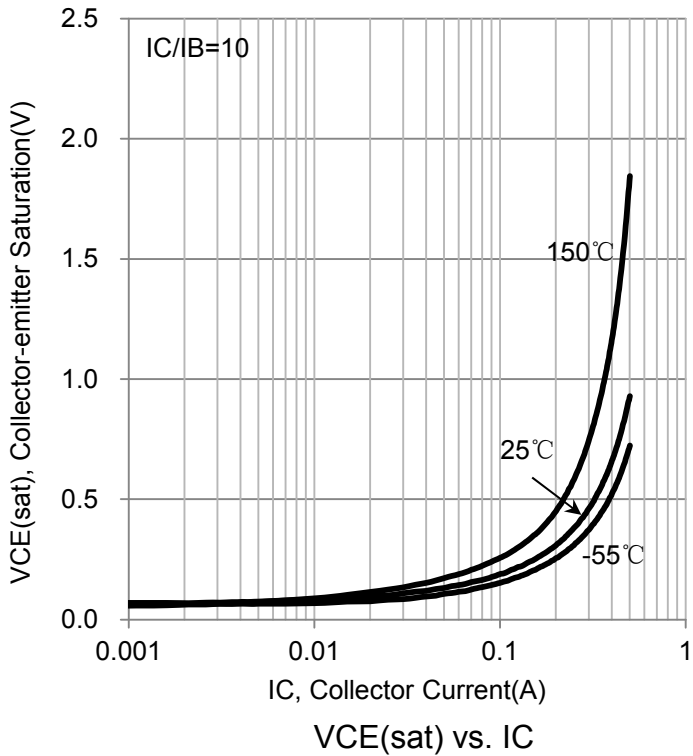
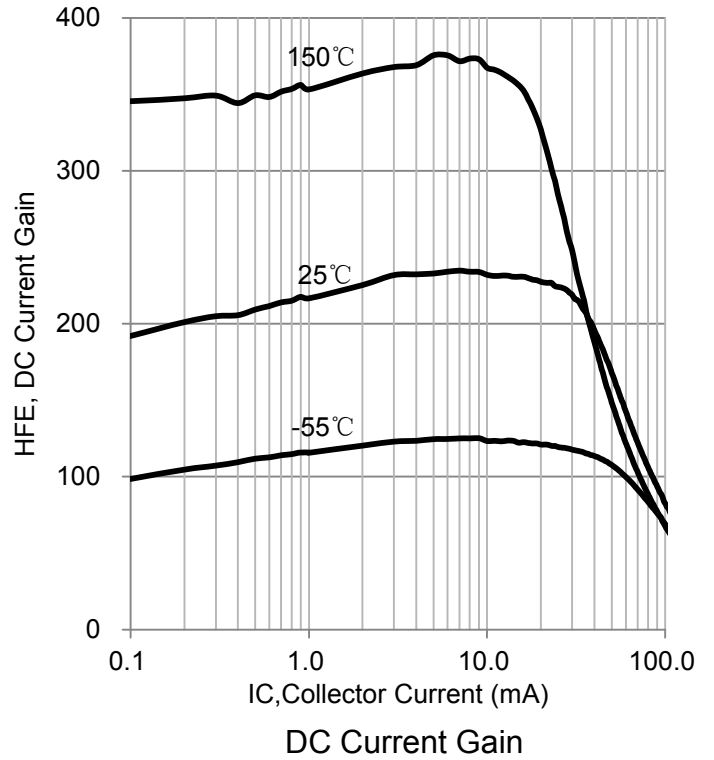
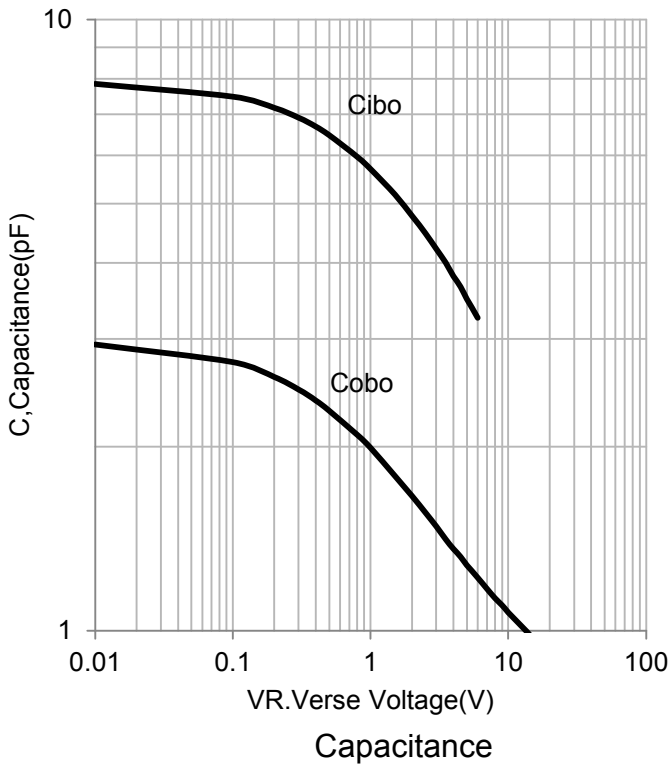

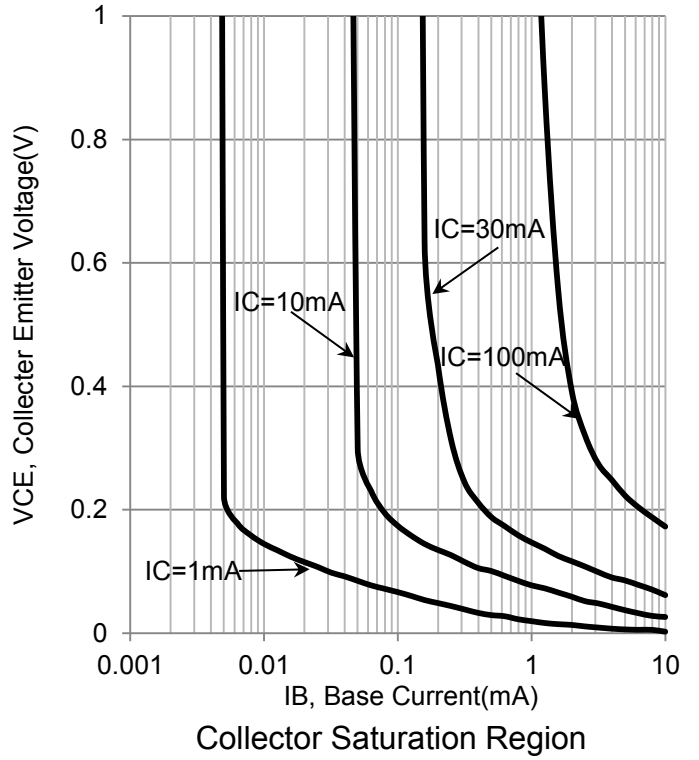
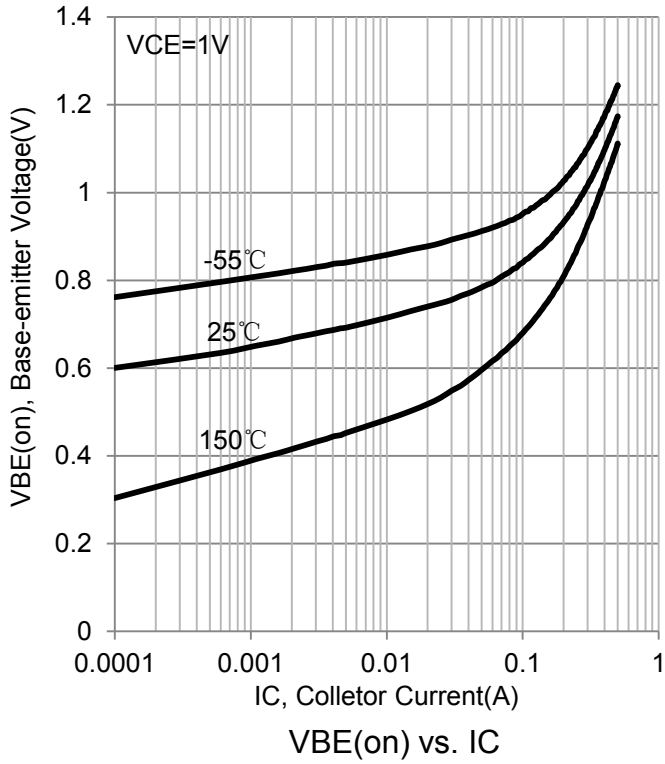

7.OUTLINE AND DIMENSIONS

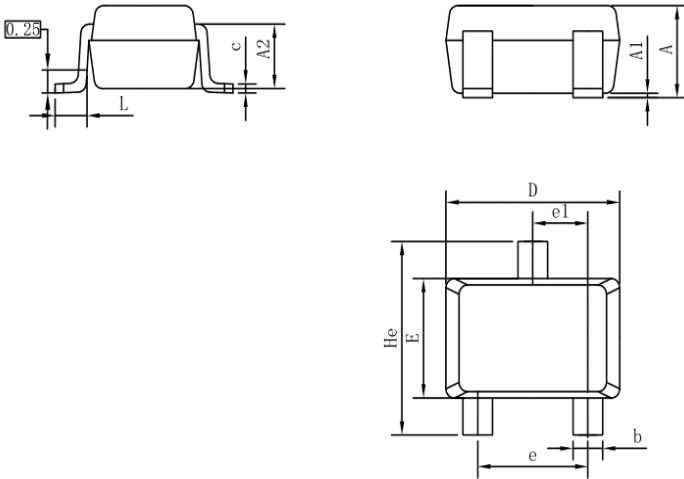

SC70			
DIM	MIN	NOR	MAX
A	0.80	0.95	1.00
A1	0.00	0.05	0.10
A2	0.7 REF		
b	0.30	0.35	0.40
c	0.10	0.15	0.25
D	1.80	2.05	2.20
E	1.15	1.30	1.35
e	1.20	1.30	1.40
e1	0.65 BSC		
L	0.20	0.35	0.56
He	2.00	2.10	2.40
ALL Dimension in mm			

8.SOLDERING FOOTPRINT

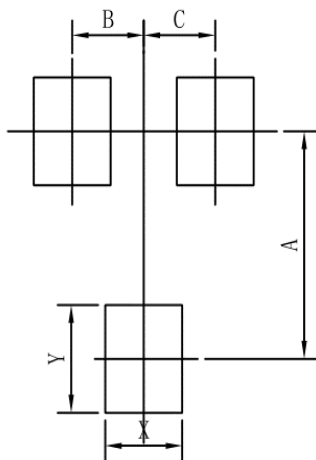

SC70	
DIM	MIN
A	1.90
B	0.65
C	0.65
X	0.70
Y	0.90