

### FEATURE

- Simplifies Circuit Design.
- We declare that the material of product compliance with RoHS requirements.
- S- Prefix for Automotive and Other Applications Requiring Unique Site and Control Change Requirements; AEC-Q101 Qualified and PPAP Capable.

### ORDERING INFORMATION

Device	Marking	Shipping
MBT3904TT1G	MA	3000/Tape&Reel
S-MBT3904TT1G	MA	3000/Tape&Reel
MBT3904TT3G	MA	10000/Tape&Reel
S-MBT3904TT3G	MA	10000/Tape&Reel

### MAXIMUM RATINGS

Rating	Symbol	Value	Unit
Collector–Emitter Voltage	$V_{CEO}$	40	Vdc
Collector–Base Voltage	$V_{CBO}$	60	Vdc
Emitter–Base Voltage	$V_{EBO}$	6.0	Vdc
Collector Current — Continuous	$I_C$	200	mAdc

### THERMAL CHARACTERISTICS

Characteristic	Symbol	Max	Unit
Total Device Dissipation FR– 4 Board, (1) $T_A = 25^\circ\text{C}$	$P_D$	200	mW
Derate above $25^\circ\text{C}$		1.6	mW/ $^\circ\text{C}$
Thermal Resistance, Junction to Ambient	$R_{\theta JA}$	600	$^\circ\text{C}/\text{W}$
Total Device Dissipation FR-4 Board(2), $T_A = 25^\circ\text{C}$	$P_D$	300	mW
Derate above $25^\circ\text{C}$		2.4	mW/ $^\circ\text{C}$
Thermal Resistance, Junction to Ambient	$R_{\theta JA}$	400	$^\circ\text{C}/\text{W}$
Junction and Storage Temperature	$T_J, T_{sig}$	-55 to +150	$^\circ\text{C}$

### DEVICE MARKING

LMBT3904TT1G = MA

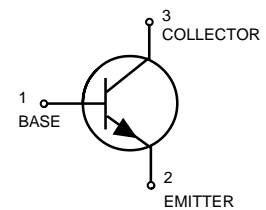
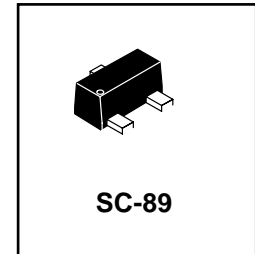
### ELECTRICAL CHARACTERISTICS ( $T_A = 25^\circ\text{C}$ unless otherwise noted.)

Characteristic	Symbol	Min	Max	Unit
----------------	--------	-----	-----	------

### OFF CHARACTERISTICS

Collector–Emitter Breakdown Voltage(3) ( $I_C = 1.0 \text{ mAdc}$ )	$V_{(BR)CEO}$	40	—	Vdc
Collector–Base Breakdown Voltage ( $I_C = 10 \mu\text{Adc}$ )	$V_{(BR)CBO}$	60	—	Vdc
Emitter–Base Breakdown Voltage ( $I_E = 10 \mu\text{Adc}$ )	$V_{(BR)EBO}$	6.0	—	Vdc
Base Cutoff Current ( $V_{CE} = 30 \text{ Vdc}, V_{EB} = 3.0 \text{ Vdc}$ )	$I_{BL}$	—	50	nAdc
Collector Cutoff Current ( $V_{CE} = 30 \text{ Vdc}, V_{EB} = 3.0 \text{ Vdc}$ )	$I_{CEX}$	—	50	nAdc

1. FR-4 Minimum Pad.
2. FR-4 1.0 x 1.0 Inch Pad.
3. Pulse Test: Pulse Width  $\leq 300 \mu\text{s}$ , Duty Cycle  $\leq 2.0\%$ .



**ELECTRICAL CHARACTERISTICS** ( $T_A = 25^\circ\text{C}$  unless otherwise noted) (Continued)

Characteristic	Symbol	Min	Max	Unit
----------------	--------	-----	-----	------

**ON CHARACTERISTICS (3)**

DC Current Gain(1) ( $I_C = 0.1 \text{ mAdc}$ , $V_{CE} = 1.0 \text{ Vdc}$ ) ( $I_C = 1.0 \text{ mAdc}$ , $V_{CE} = 1.0 \text{ Vdc}$ ) ( $I_C = 10 \text{ mAdc}$ , $V_{CE} = 1.0 \text{ Vdc}$ ) ( $I_C = 50 \text{ mAdc}$ , $V_{CE} = 1.0 \text{ Vdc}$ ) ( $I_C = 100 \text{ mAdc}$ , $V_{CE} = 1.0 \text{ Vdc}$ )	$h_{FE}$	40 70 100 60 30	— — 300 — —	—
Collector–Emitter Saturation Voltage ( $I_C = 10 \text{ mAdc}$ , $I_B = 1.0 \text{ mAdc}$ )(3) ( $I_C = 50 \text{ mAdc}$ , $I_B = 5.0 \text{ mAdc}$ )	$V_{CE(sat)}$	— —	0.2 0.3	Vdc
Base–Emitter Saturation Voltage(3) ( $I_C = 10 \text{ mAdc}$ , $I_B = 1.0 \text{ mAdc}$ ) ( $I_C = 50 \text{ mAdc}$ , $I_B = 5.0 \text{ mAdc}$ )	$V_{BE(sat)}$	0.65 —	0.85 0.95	Vdc

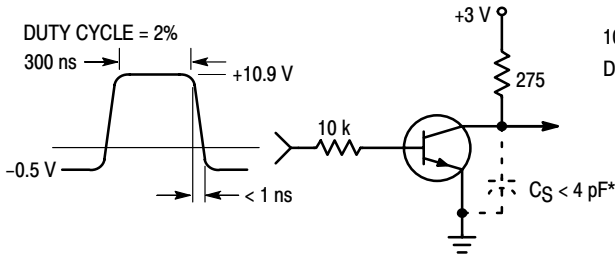
**SMALL–SIGNAL CHARACTERISTICS**

Current–Gain — Bandwidth Product ( $I_C = 10 \text{ mAdc}$ , $V_{CE} = 20 \text{ Vdc}$ , $f = 100 \text{ MHz}$ )	$f_T$	200	—	MHz
Output Capacitance ( $V_{CB} = 5.0 \text{ Vdc}$ , $I_E = 0$ , $f = 1.0 \text{ MHz}$ )	$C_{obo}$	—	4.0	pF
Input Capacitance ( $V_{BE} = 0.5 \text{ Vdc}$ , $I_C = 0$ , $f = 1.0 \text{ MHz}$ )	$C_{ibo}$	—	8.0	pF
Input Impedance ( $V_{CE} = 10 \text{ Vdc}$ , $I_C = 1.0 \text{ mAdc}$ , $f = 1.0 \text{ kHz}$ )	$h_{ie}$	1.0	10	pF
Voltage Feedback Ratio ( $V_{CE} = 10 \text{ Vdc}$ , $I_C = 1.0 \text{ mAdc}$ , $f = 1.0 \text{ kHz}$ )	$h_{re}$	0.5	8.0	$\times 10^{-4}$
Small–Signal Current Gain ( $V_{CE} = 10 \text{ Vdc}$ , $I_C = 1.0 \text{ mAdc}$ , $f = 1.0 \text{ kHz}$ )	$h_{fe}$	100	400	—
Output Admittance ( $V_{CE} = 10 \text{ Vdc}$ , $I_C = 1.0 \text{ mAdc}$ , $f = 1.0 \text{ kHz}$ )	$h_{oe}$	1.0	40	$\text{mhos}$
Noise Figure ( $V_{CE} = 5.0 \text{ Vdc}$ , $I_C = 100 \mu\text{Adc}$ , $R_s = 1.0 \text{ k}\Omega$ , $f = 1.0 \text{ kHz}$ )	NF	—	5.0	dB

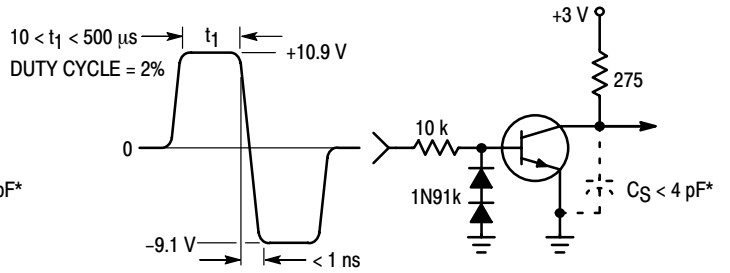
**SWITCHING CHARACTERISTICS**

Delay Time ( $V_{CC} = 3.0 \text{ Vdc}$ , $V_{BE} = 0.5 \text{ Vdc}$ )	$t_d$	—	35	ns
Rise Time ( $I_C = 10 \text{ mAdc}$ , $I_{B1} = 1.0 \text{ mAdc}$ )	$t_r$	—	35	ns
Storage Time ( $V_{CC} = 3.0 \text{ Vdc}$ )	$t_s$	—	200	ns
Fall Time ( $I_C = 10 \text{ mAdc}$ , $I_{B1} = I_{B2} = 1.0 \text{ mAdc}$ )	$t_f$	—	50	ns

3. Pulse Test: Pulse Width  $\leq 300 \mu\text{s}$ , Duty Cycle  $\leq 2.0\%$ .

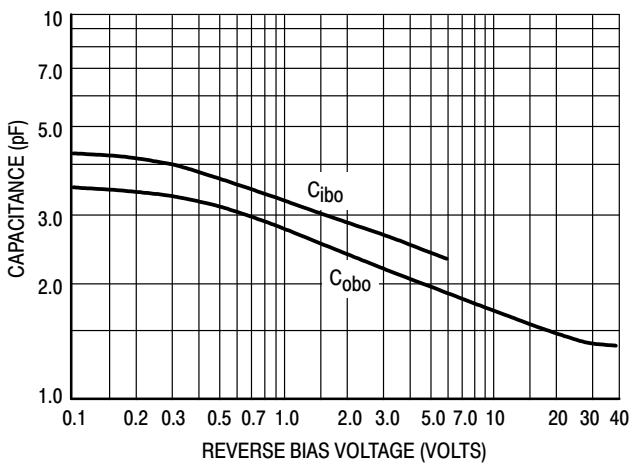


**Figure 1. Delay and Rise Time  
 Equivalent Test Circuit**

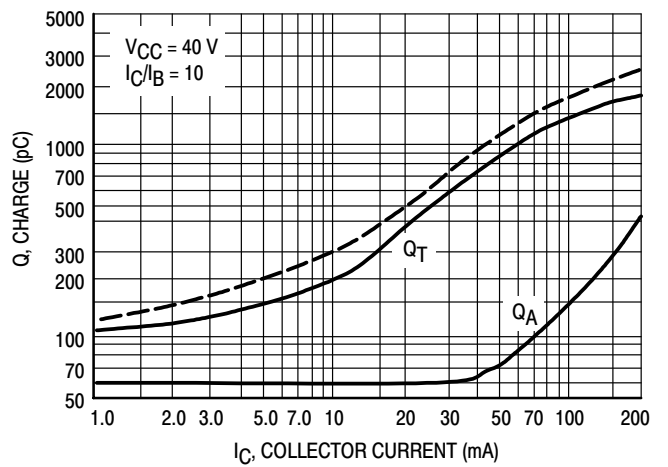


**Figure 2. Storage and Fall Time  
 Equivalent Test Circuit**

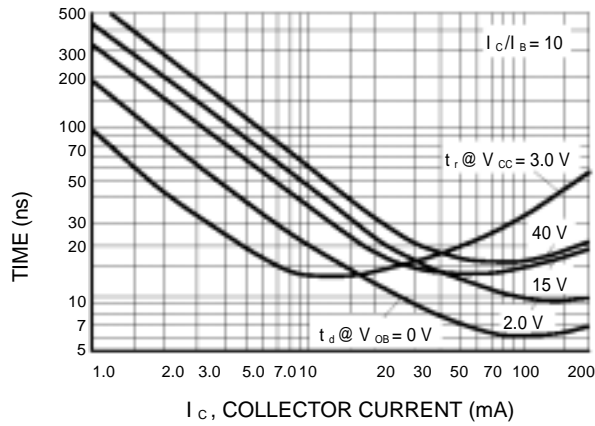
\* Total shunt capacitance of test jig and connectors



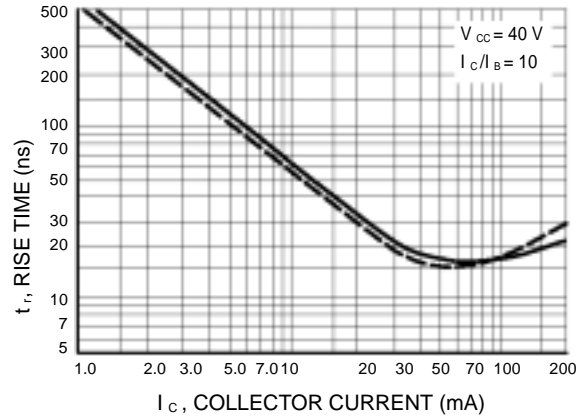
**Figure 3. Capacitance**



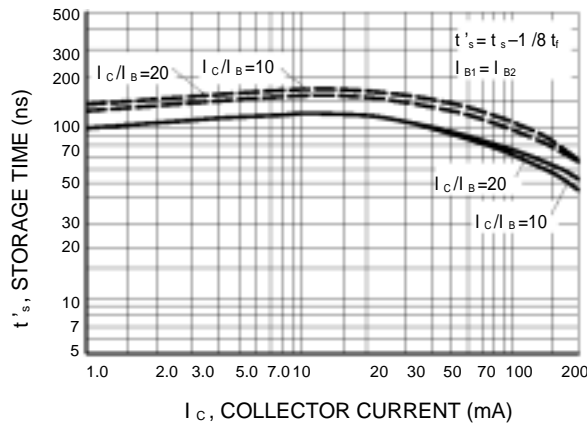
**Figure 4. Charge Data**



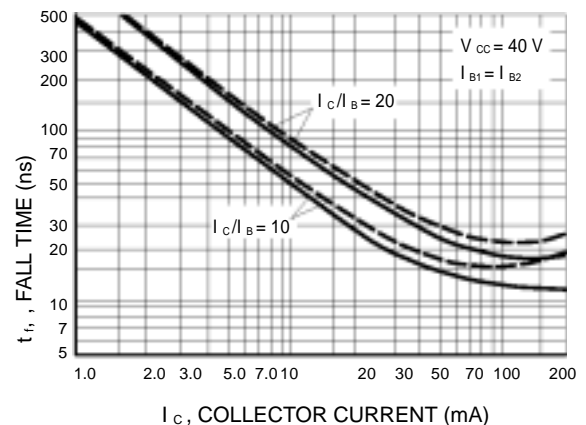
**Figure 5. Turn-On Time**



**Figure 6. Rise Time**



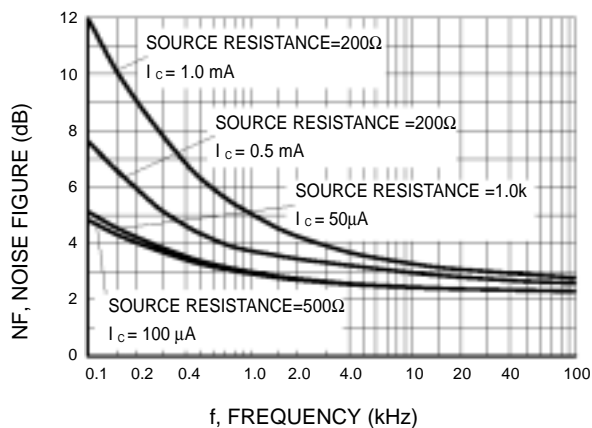
**Figure 7. Storage Time**



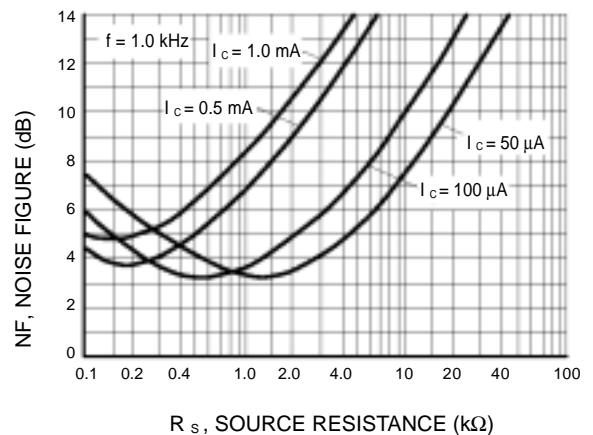
**Figure 8. Fall Time**

**TYPICAL AUDIO SMALL-SIGNAL CHARACTERISTICS  
NOISE FIGURE VARIATIONS**

( $V_{CE} = 5.0 \text{ Vdc}$ ,  $T_A = 25^\circ\text{C}$ , Bandwidth = 1.0 Hz)



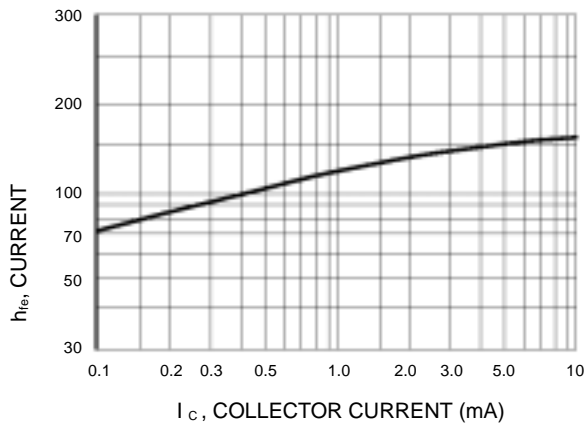
**Figure 9.**



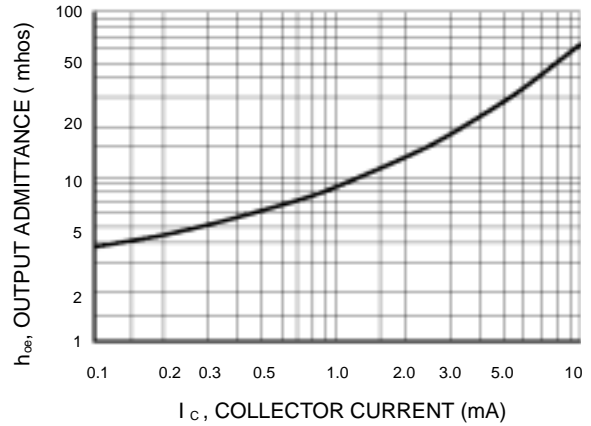
**Figure 10.**

**h PARAMETERS**

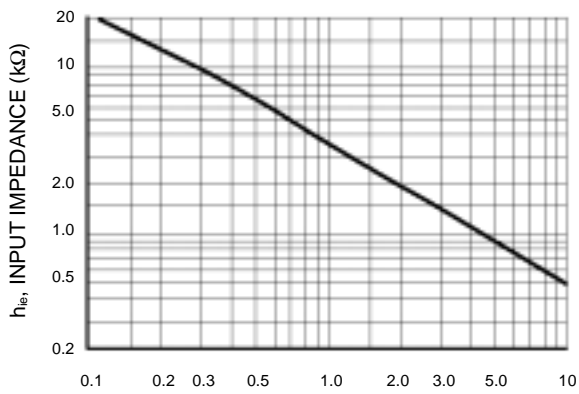
( $V_{CE} = 10 \text{ Vdc}$ ,  $f = 1.0 \text{ kHz}$ ,  $T_A = 25^\circ\text{C}$ )



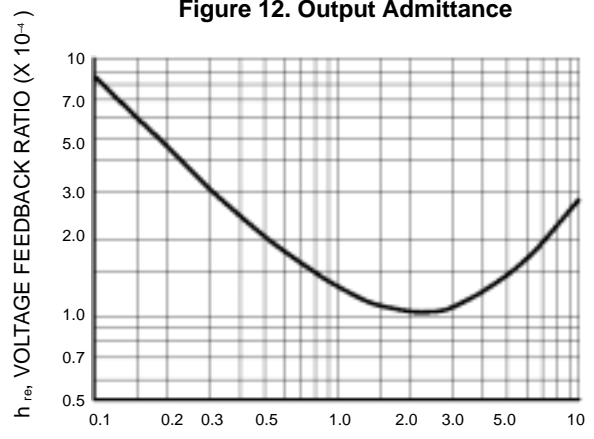
**Figure 11. Current Gain**



**Figure 12. Output Admittance**

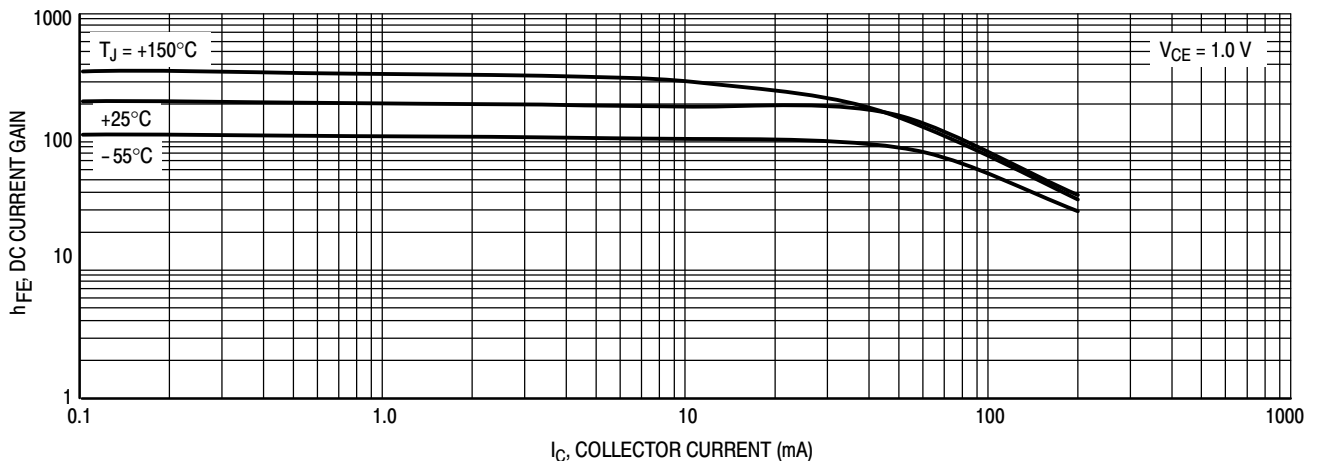


**Figure 13. Input Impedance**

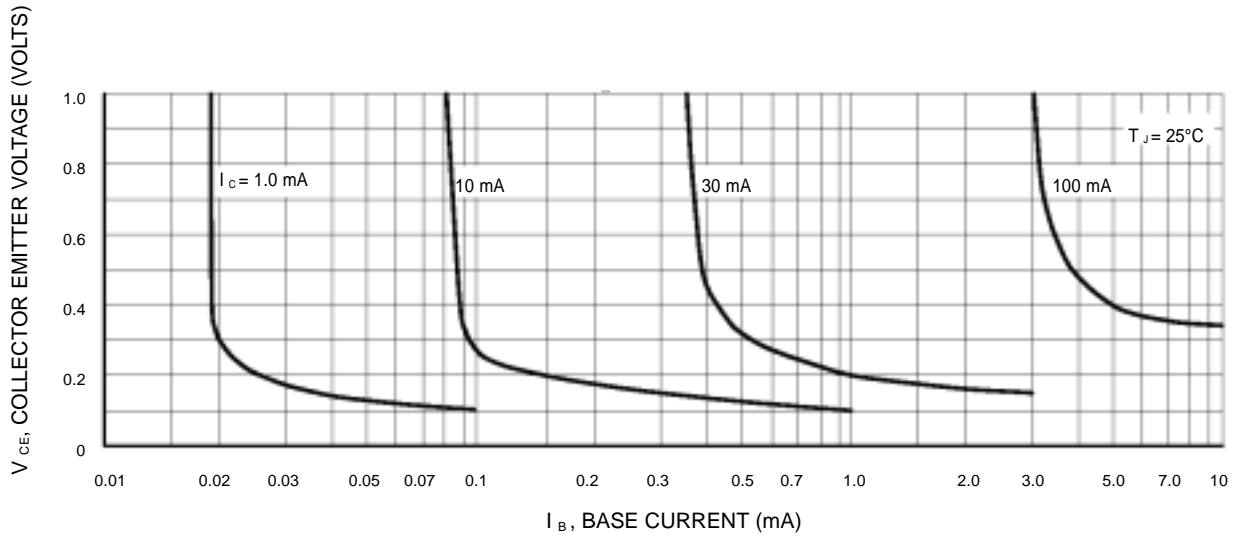


**Figure 14. Voltage Feedback Ratio**

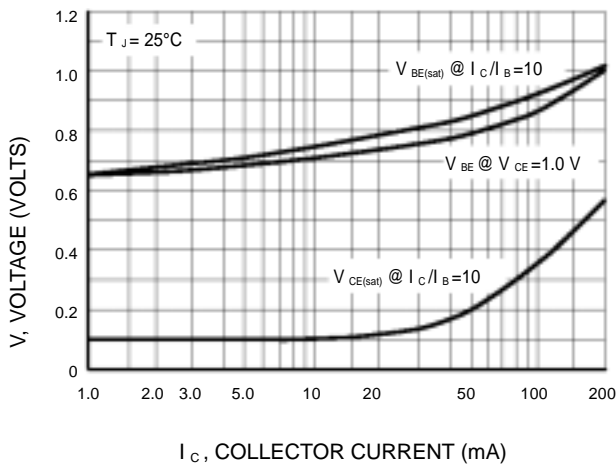
**TYPICAL STATIC CHARACTERISTICS**



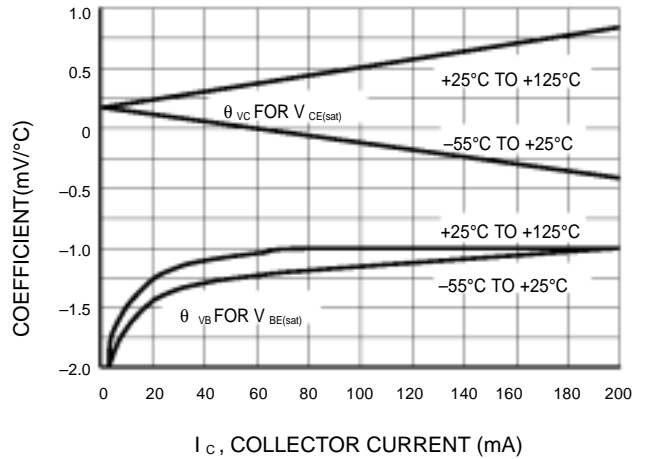
**Figure 15. DC Current Gain**



**Figure 16. Collector Saturation Region**

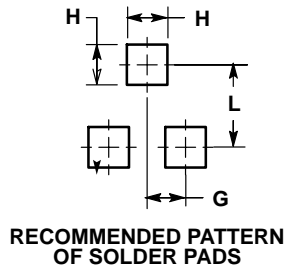
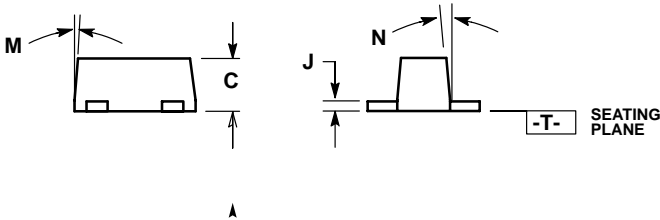
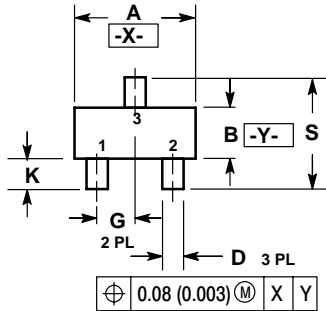


**Figure 17. "ON" Voltages**



**Figure 18. Temperature Coefficients**

SC-89



**NOTES:**

1. DIMENSIONING AND TOLERANCING PER ANSI Y14.5M, 1982.
2. CONTROLLING DIMENSION: MILLIMETERS
3. MAXIMUM LEAD THICKNESS INCLUDES LEAD FINISH THICKNESS. MINIMUM LEAD THICKNESS IS THE MINIMUM THICKNESS OF BASE MATERIAL.
4. 463C-01 OBSOLETE, NEW STANDARD 463C-02.

DIM	MILLIMETERS			INCHES		
	MIN	NOM	MAX	MIN	NOM	MAX
A	1.50	1.60	1.70	0.059	0.063	0.067
B	0.75	0.85	0.95	0.030	0.034	0.040
C	0.60	0.70	0.80	0.024	0.028	0.031
D	0.23	0.28	0.33	0.009	0.011	0.013
G	0.50 BSC			0.020 BSC		
H	0.53 REF			0.021 REF		
J	0.10	0.15	0.20	0.004	0.006	0.008
K	0.30	0.40	0.50	0.012	0.016	0.020
L	1.10 REF			0.043 REF		
M	---	---	10 <sup>°</sup>	---	---	10 <sup>°</sup>
N	---	---	10 <sup>°</sup>	---	---	10 <sup>°</sup>
S	1.50	1.60	1.70	0.059	0.063	0.067