

Features

- We declare that the material of product compliance with RoHS requirements.
- S- Prefix for Automotive and Other Applications Requiring Unique Site and Control Change Requirements; AEC-Q101 Qualified and PPAP Capable.

MAXIMUM RATINGS

Rating	Symbol	Value		Unit
		2907	2907A	
Collector–Emitter Voltage	V_{CEO}	-40	-60	Vdc
Collector–Base Voltage	V_{CBO}	-60		Vdc
Emitter–Base Voltage	V_{EBO}	-5.0		Vdc
Collector Current — Continuous	I_C	-600		mAdc

THERMAL CHARACTERISTICS

Characteristic	Symbol	Max	Unit
Total Device Dissipation FR–5 Board, (1) $T_A = 25^\circ\text{C}$	P_D	225	mW
Derate above 25°C		1.8	mW/ $^\circ\text{C}$
Thermal Resistance, Junction to Ambient	$R_{\theta JA}$	556	$^\circ\text{C}/\text{W}$
Total Device Dissipation Alumina Substrate, (2) $T_A = 25^\circ\text{C}$	P_D	300	mW
Derate above 25°C		2.4	mW/ $^\circ\text{C}$
Thermal Resistance, Junction to Ambient	$R_{\theta JA}$	417	$^\circ\text{C}/\text{W}$
Junction and Storage Temperature	T_J, T_{stg}	-55 to +150	$^\circ\text{C}$

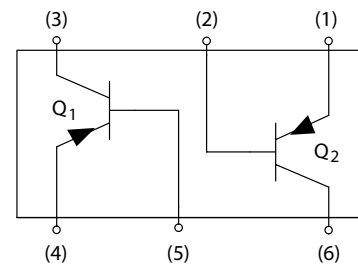
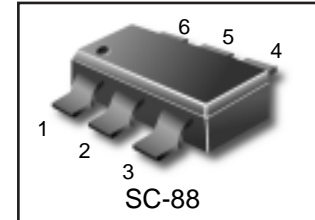

ORDERING INFORMATION

Device	Packing	Shipping
MBT2907ADW1T1G S-MBT2907ADW1T1G	SC88	3000 Units/Reel
MBT2907ADW1T3G S-MBT2907ADW1T1G	SC88	10000 Units/Reel

DEVICE MARKING

(S-)MBT2907DW1T1G = M2B, (S-)MBT2907ADW1T1G = 2F

ELECTRICAL CHARACTERISTICS ($T_A = 25^\circ\text{C}$ unless otherwise noted.)

Characteristic	Symbol	Min	Max	Unit
----------------	--------	-----	-----	------

OFF CHARACTERISTICS

Collector–Emitter Breakdown Voltage(3) ($I_C = -10\text{ mAdc}, I_B = 0$)	$V_{(BR)CEO}$			Vdc
	LMBT2907	-40	—	
	LMBT2907A	-60	—	
Collector–Emitter Breakdown Voltage($I_C = -10\ \mu\text{Adc}, I_E = 0$)	$V_{(BR)CBO}$	-60	—	Vdc
Emitter–Base Breakdown Voltage($I_E = -10\ \mu\text{Adc}, I_C = 0$)	$V_{(BR)EBO}$	-5.0	—	Vdc
Collector Cutoff Current($V_{CB} = -30\text{Vdc}, I_{BE(OFF)} = -0.5\text{Vdc}$)	I_{CEX}	—	-50	nAdc
Collector Cutoff Current ($V_{CB} = -50\text{Vdc}, I_E = 0$)	I_{CBO}			μAdc
	LMBT2907	—	-0.020	
	LMBT2907A	—	-0.010	
	LMBT2907	—	-20	
($V_{CB} = -50\text{Vdc}, I_E = 0, T_A = 125^\circ\text{C}$)	LMBT2907A	—	-10	
Base Current($V_{CE} = -30\text{Vdc}, V_{EB(OFF)} = -0.5\text{Vdc}$)	I_B	—	-50	nAdc

1. FR-5 = 1.0 x 0.75 x 0.062 in.
2. Alumina = 0.4 x 0.3 x 0.024 in. 99.5% alumina.
3. Pulse Test: Pulse Width $\leq 300\ \mu\text{s}$, Duty Cycle $\leq 2.0\%$.

ELECTRICAL CHARACTERISTICS ($T_A = 25^\circ\text{C}$ unless otherwise noted) (Continued)

Characteristic	Symbol	Min	Max	Unit
ON CHARACTERISTICS				
DC Current Gain ($I_C = -0.1\text{mA}$, $V_{CE} = -10\text{Vdc}$)	h_{FE}	35	—	—
		MBT2907	75	—
($I_C = -1.0\text{mA}$, $V_{CE} = -10\text{Vdc}$)		50	—	
		MBT2907A	100	—
($I_C = -10\text{mA}$, $V_{CE} = -10\text{Vdc}$)		75	—	
		MBT2907A	100	—
($I_C = -150\text{mA}$, $V_{CE} = -10\text{Vdc}$)(3)		—	—	
		MBT2907A	100	300
($I_C = -500\text{mA}$, $V_{CE} = -10\text{Vdc}$)(3)		30	—	
		MBT2907A	50	—
Collector–Emitter Saturation Voltage(3) ($I_C = -150\text{mA}$, $I_B = -15\text{mA}$) ($I_C = -500\text{mA}$, $I_B = -50\text{mA}$)	$V_{CE(sat)}$	—	-0.4	Vdc
		—	-1.6	
Base–Emitter Saturation Voltage(3) ($I_C = -150\text{mA}$, $I_B = -15\text{mA}$) ($I_C = -500\text{mA}$, $I_B = -50\text{mA}$)	$V_{BE(sat)}$	—	-1.3	Vdc
		—	-2.6	

SMALL-SIGNAL CHARACTERISTICS

Current–Gain — Bandwidth Product(3),(4) ($I_C = -50\text{mA}$, $V_{CE} = -20\text{Vdc}$, $f = 100\text{MHz}$)	f_T	200	—	MHz
Output Capacitance ($V_{CB} = -10\text{Vdc}$, $I_E = 0$, $f = 1.0\text{MHz}$)	C_{obo}	—	8.0	pF
Input Capacitance ($V_{EB} = -2.0\text{Vdc}$, $I_C = 0$, $f = 1.0\text{MHz}$)	C_{ibo}	—	30	pF

SWITCHING CHARACTERISTICS

Turn–On Time Delay Time Rise Time	($V_{CC} = -30\text{Vdc}$, $I_C = -150\text{mA}$, $I_{B1} = -15\text{mA}$)	t_{on} t^d t_r	— — —	45 10 40	ns
Fall Time Storage Time Turn–Off Time	($V_{CC} = -6.0\text{Vdc}$, $I_C = -150\text{mA}$, $I_{B1} = I_{B2} = 15\text{mA}$)	t_f t_s t_{off}	— — —	60 225 280	ns

3. Pulse Test: Pulse Width < 300 μs , Duty Cycle < 2.0%.

4. f_T is defined as the frequency at which $|h_{fe}|$ extrapolates to unity.

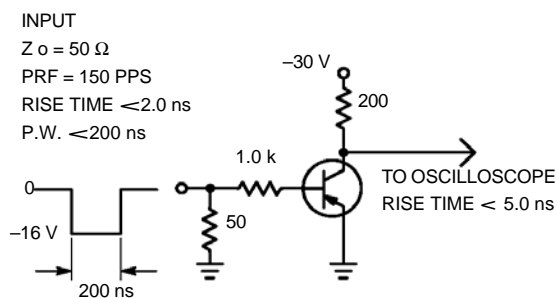

Figure 1. Delay and Rise Time Test Circuit

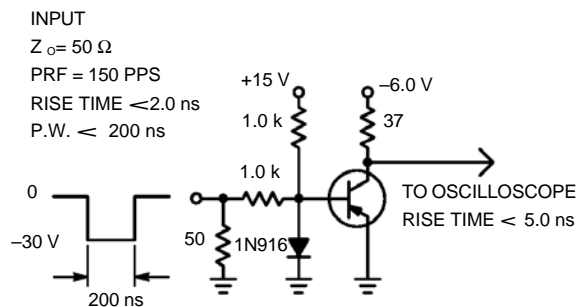

Figure 2. Storage and Fall Time Test Circuit

TYPICAL CHARACTERISTICS

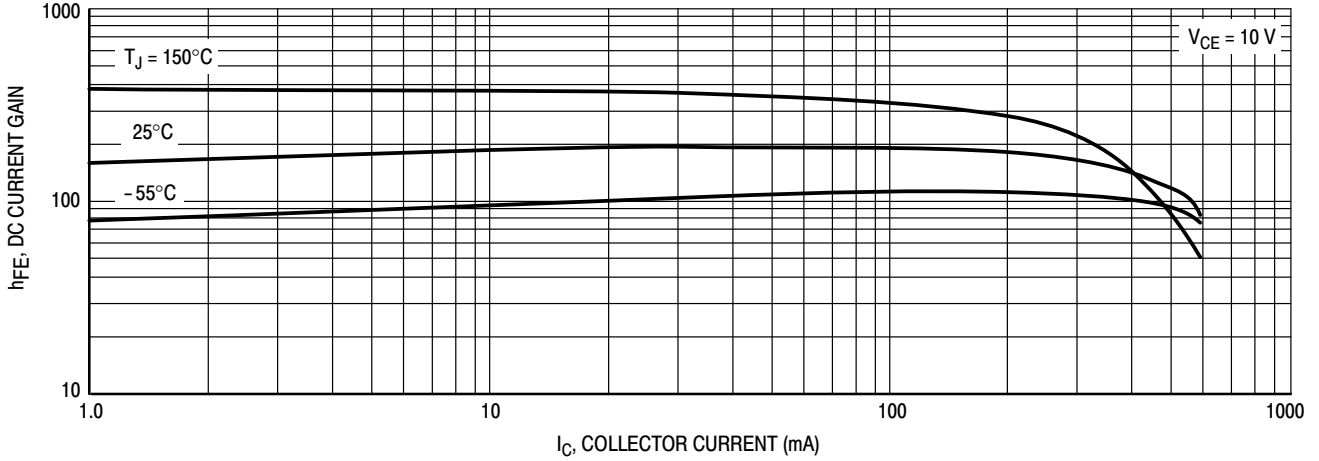

Figure 3. DC Current Gain

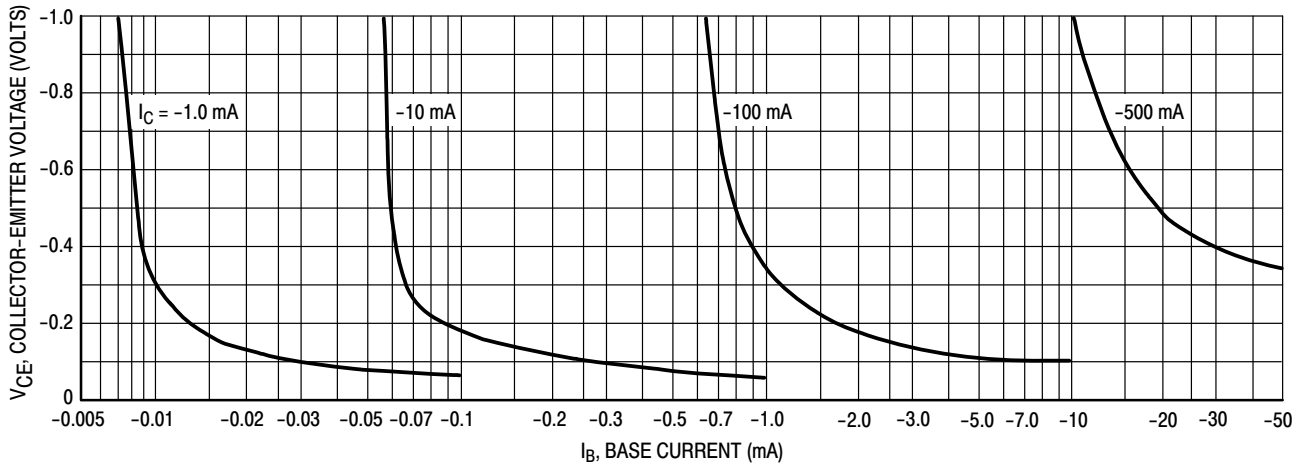

Figure 4. Collector Saturation Region

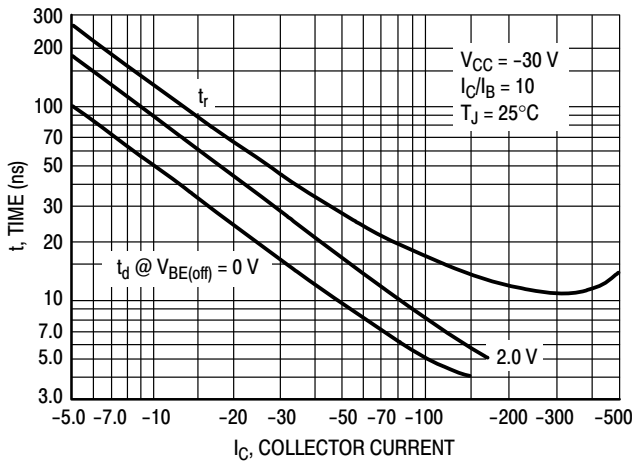

Figure 5. Turn-On Time

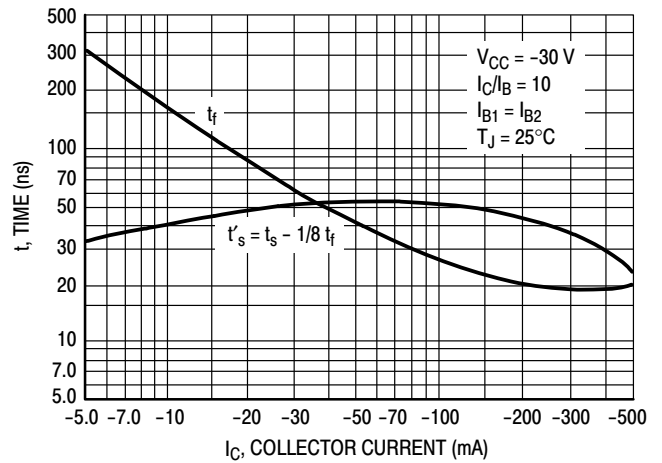

Figure 6. Turn-Off Time

TYPICAL SMALL-SIGNAL CHARACTERISTICS

NOISE FIGURE

$V_{CE} = 10 \text{ Vdc}, T_A = 25^\circ\text{C}$

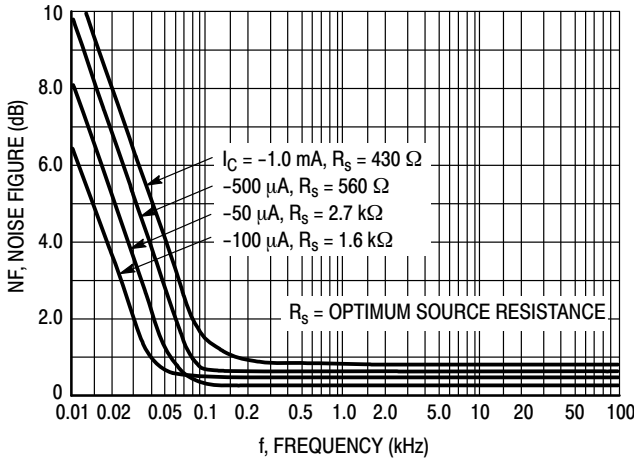

Figure 7. Frequency Effects

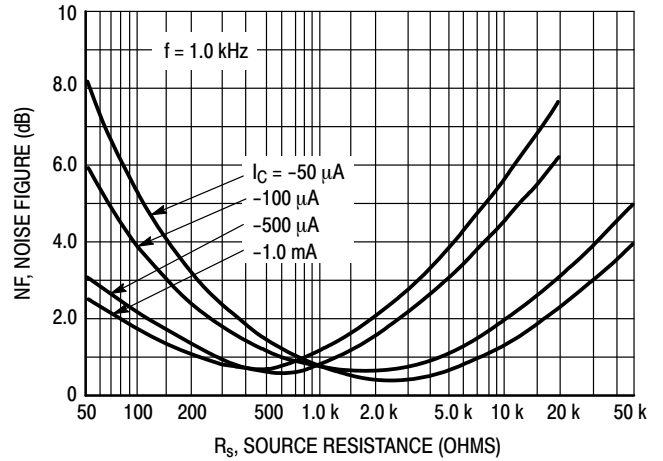

Figure 8. Source Resistance Effects

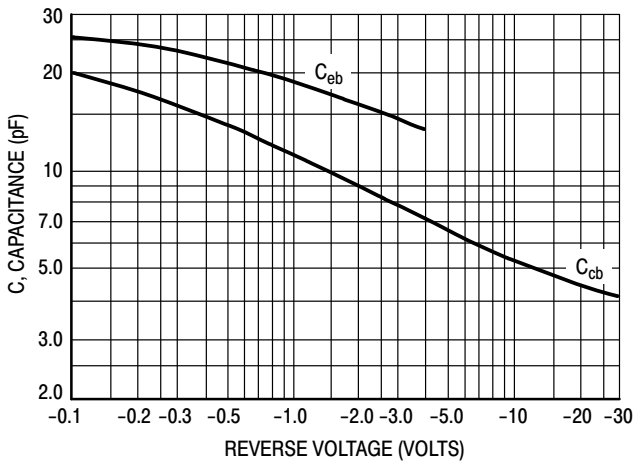

Figure 9. Capacitances

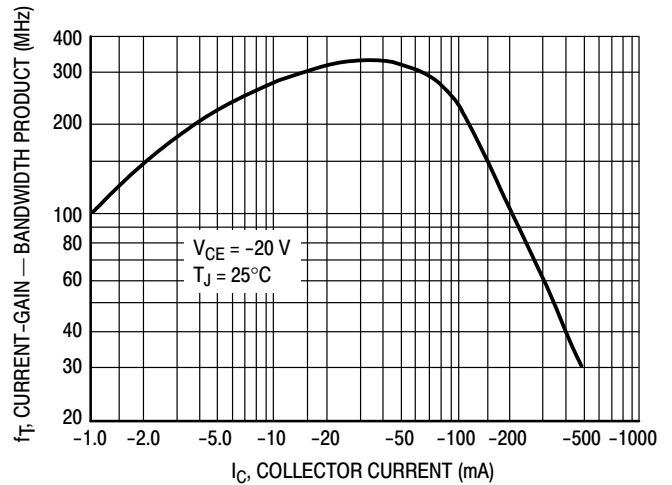

Figure 10. Current-Gain - Bandwidth Product

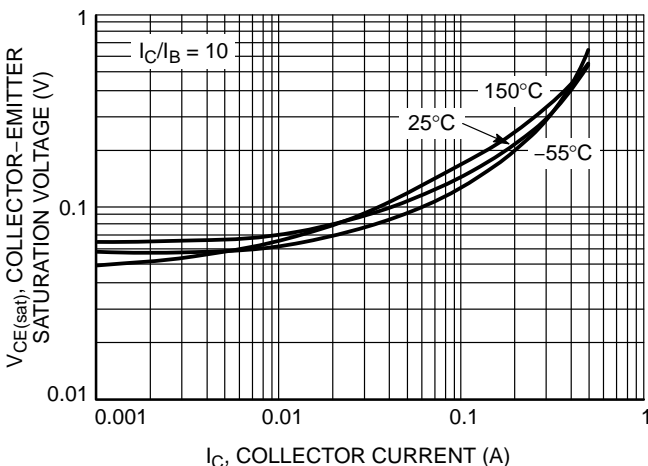

Figure 11. Collector Emitter Saturation Voltage vs. Collector Current

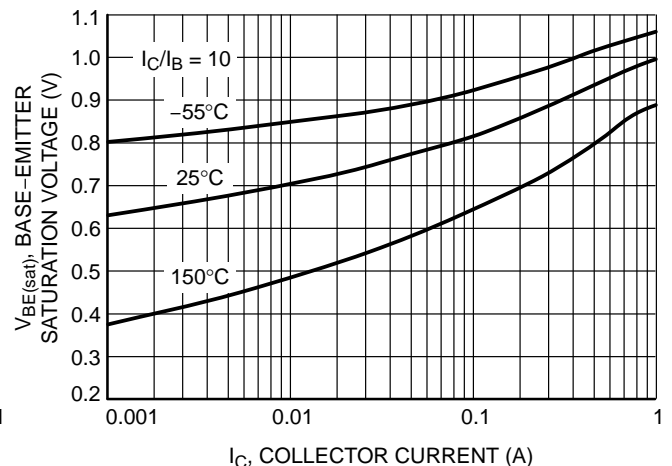

Figure 12. Base Emitter Saturation Voltage vs. Collector Current

TYPICAL SMALL-SIGNAL Characteristics
NOISE FIGURE

$V_{CE} = 10 \text{ Vdc}$, $T_A = 25^\circ\text{C}$

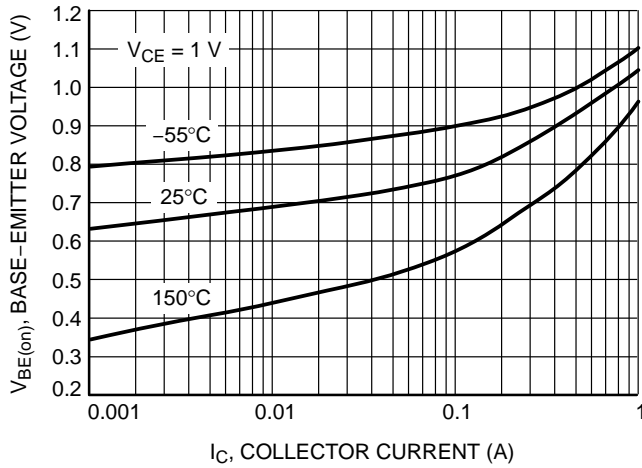

Figure 13. Base Emitter Voltage vs. Collector Current

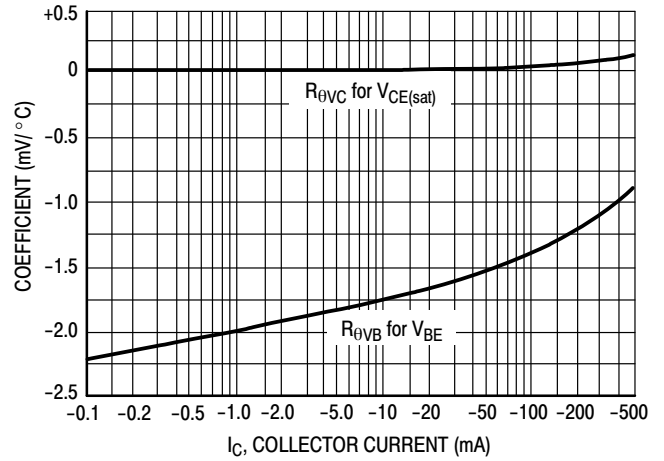

Figure 14. Temperature Coefficients

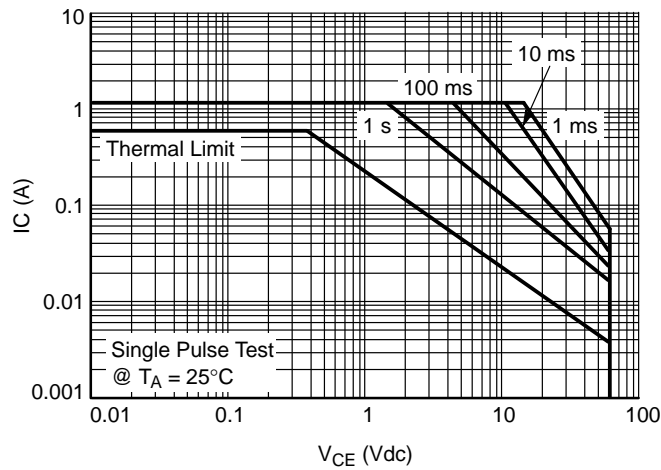
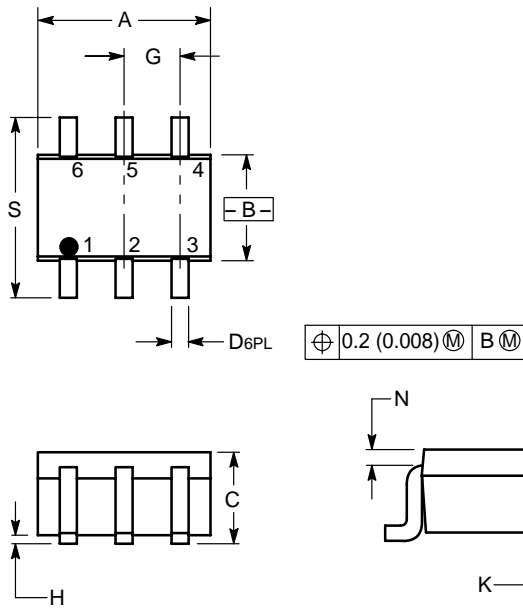

Figure 15. Safe Operating Area

SC-88/SOT-363



NOTES:

1. DIMENSIONING AND TOLERANCING PER ANSI Y14.5M, 1982.
2. CONTROLLING DIMENSION: INCH.

DIM	INCHES		MILLIMETERS	
	MIN	MAX	MIN	MAX
A	0.071	0.087	1.80	2.20
B	0.045	0.053	1.15	1.35
C	0.031	0.043	0.80	1.10
D	0.004	0.012	0.10	0.30
G	0.026 BSC		0.65 BSC	
H	---	0.004	---	0.10
J	0.004	0.010	0.10	0.25
K	0.004	0.012	0.10	0.30
N	0.008 REF		0.20 REF	
S	0.079	0.087	2.00	2.20

- PIN 1. EMITTER 2
 2. BASE 2
 3. COLLECTOR 1
 4. EMITTER 1
 5. BASE 1
 6. COLLECTOR 2

