

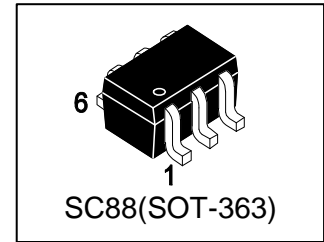

1. FEATURES

- We declare that the material of product compliance with RoHS requirements and Halogen Free.
- S- prefix for automotive and other applications requiring unique site and control change requirements; AEC-Q101 qualified and PPAP capable.



2. DEVICE MARKING AND ORDERING INFORMATION

Device	Marking	Shipping
BSS8402DW1T1G	402	3000/Tape&Reel
BSS8402DW1T3G	402	10000/Tape&Reel

3. MAXIMUM RATINGS(Ta = 25°C)

Parameter	Symbol	Limits	Unit
Drain–Source Voltage	VDSS	50	V
Gate–to–Source Voltage – Continuous	VGS	±20	V
Drain Current			mA
– Continuous (Ta = 25°C)	ID	130	
– Pulsed Drain Current (tp ≤ 10 μs)	IDM	520	
Total Power Dissipation @ TA = 25°C	PD	380	mW
Thermal Resistance, Junction–to–Ambient	ROJA	328	°C/W
Junction and Storage temperature range	TJ,Tstg	–55~+150	°C
Maximum Lead Temperature for Soldering Purposes, for 10 seconds	TL	260	°C

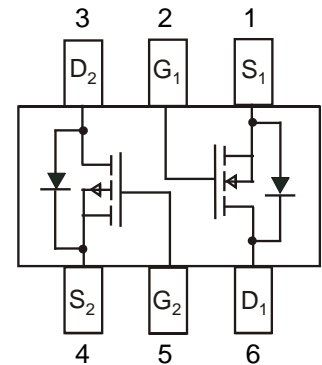



4. ELECTRICAL CHARACTERISTICS (Ta= 25°C)

N-Channel

OFF CHARACTERISTICS

Characteristic	Symbol	Min.	Typ.	Max.	Unit
Drain–Source Breakdown Voltage (VGS = 0, ID = 250 μ A)	VBRDSS	50	-	-	V
Zero Gate Voltage Drain Current (VDS = 25 V, VGS = 0 V)	IDSS	-	-	0.1	μ A
(VDS = 50 V, VGS = 0 V)		-	-	0.5	
Gate–Source Leakage Current (VGS = \pm 20 V, VDS = 0 V)	IGSS	-	-	\pm 0.1	μ A

ON CHARACTERISTICS (Note 1)

Gate–Source Threshold Voltage (VDS = VGS, ID = 1.0 mA)	VGS(th)	0.5	-	1.5	V
Static Drain–Source On–State Resistance (VGS= 2.75 V, ID < 200 mA, TA = –40°C to +85°C)	RDS(on)	-	5.6	10	Ohm
(VGS = 5.0 V, ID = 200 mA)		-	-	3.5	

DYNAMIC CHARACTERISTICS

Input Capacitance (VDS = 25 V, VGS = 0, f = 1 MHz)	Ciss	-	42	-	pF
Output Capacitance (VDS = 25 V, VGS = 0, f = 1 MHz)	Coss	-	15	-	pF
Transfer Capacitance (VDS = 25 V, VGS = 0, f = 1 MHz)	Crss	-	3	-	pF

SWITCHING CHARACTERISTICS (Note 2)

Turn-On Delay Time	(VDD = 30 V, ID = 0.2A)	td(on)	-	5	-	ns
Turn-Off Delay Time		td(off)	-	7	-	

**4 ELECTRICAL CHARACTERISTICS (Ta= 25°C)(Con.)****P-Channel**

OFF CHARACTERISTICS

Characteristic	Symbol	Min.	Typ.	Max.	Unit
Drain–Source Breakdown Voltage (VGS = 0, ID = -250μA)	VBRDSS	-50	-	-	V
Zero Gate Voltage Drain Current (VDS = -25 V, VGS = 0 V) (VDS = -50 V, VGS = 0 V) (VDS = -50 V, VGS = 0 V, TJ = 125°C)	IDSS	-	-	-0.1 -15 -60	μA
Gate–Source Leakage Current (VGS = ± 20 V, VDS = 0 V)	IGSS	-	-	±0.1	μA

ON CHARACTERISTICS (Note 1)

Gate–Source Threshold Voltage (VDS = VGS, ID = -250 μA)	VGS(th)	-0.8	-	-2.0	V
Static Drain–Source On–State Resistance (VGS = -5.0 V, ID = -100 mA)	RDS(on)	-	5	10	Ohm

DYNAMIC CHARACTERISTICS

Input Capacitance (VDS = -5 V)	Ciss	-	30	-	pF
Output Capacitance (VDS = -5 V)	Coss	-	10	-	pF
Transfer Capacitance (VDS = -5 V)	Crss	-	5	-	pF

SWITCHING CHARACTERISTICS(Note 2)

Turn–On Delay Time	(VDS = -15 V, VGS = -10 V , RL = 50Ω, RG = 25Ω)	td(on)	-	16.7	-	ns
Rise Time		tr	-	8.6	-	
Turn–Off Delay Time		td(off)	-	17.9	-	
Fall Time		tf	-	5.3	-	
Gate Charge		QT	-	6000	-	pC

1. Pulse Test: Pulse Width $\leq 300 \mu\text{s}$, Duty Cycle $\leq 2.0\%$.

2. Switching characteristics are independent of operating junction temperature.



5.ELECTRICAL CHARACTERISTICS CURVES

N-Channel

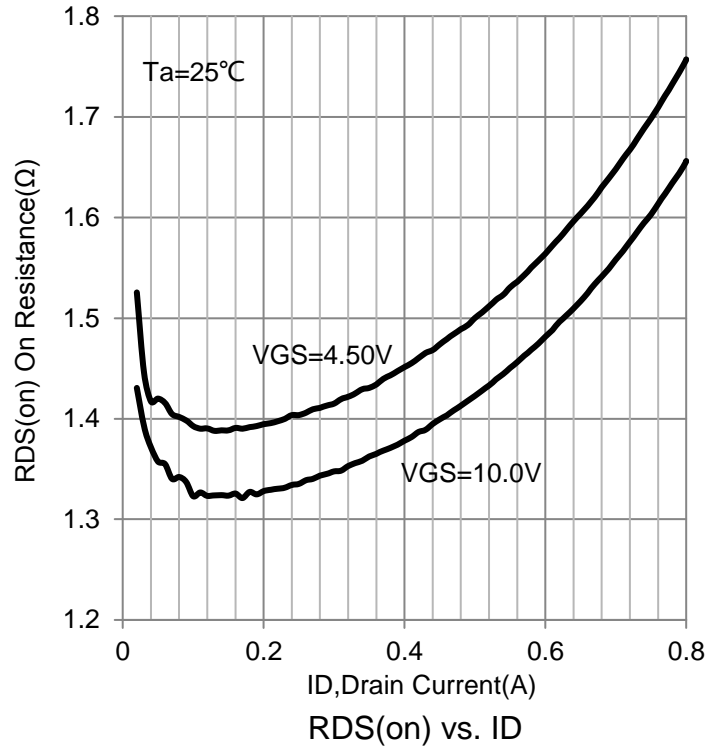
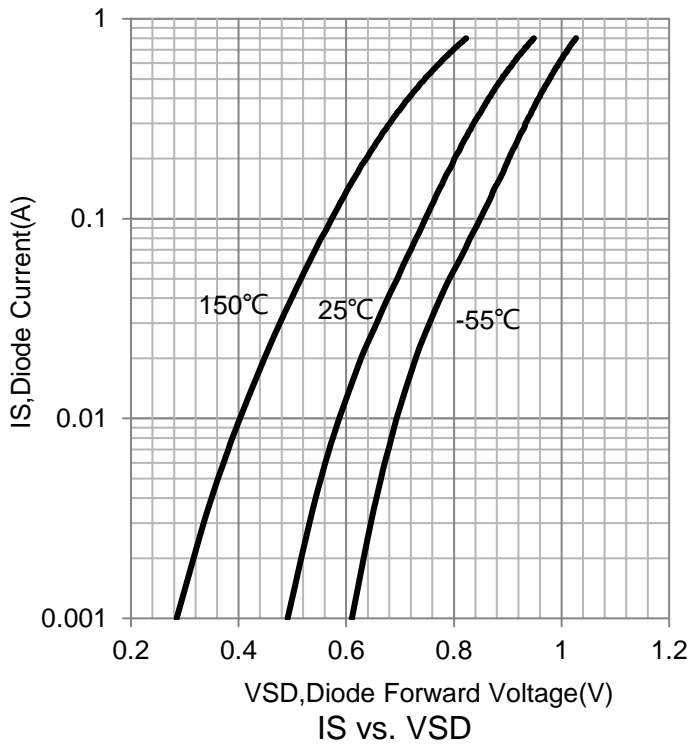
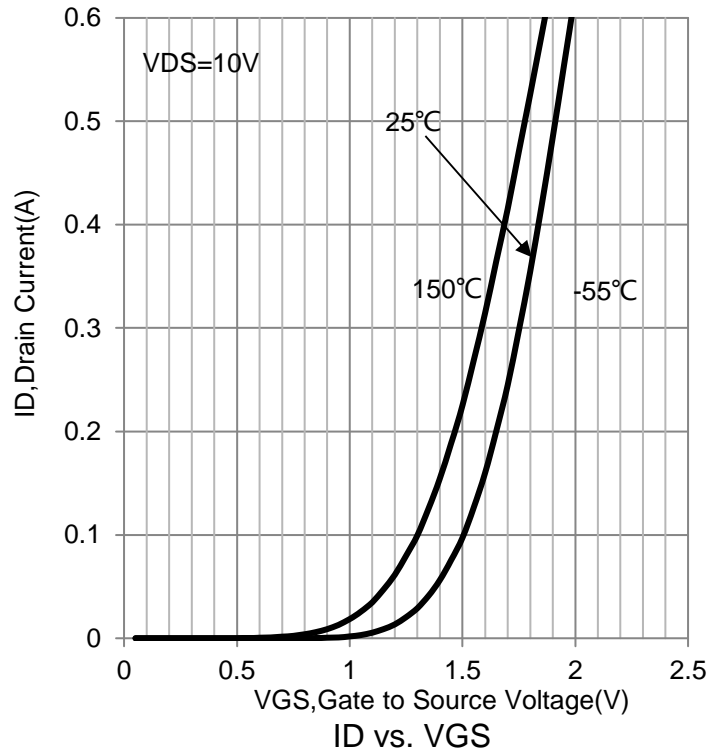
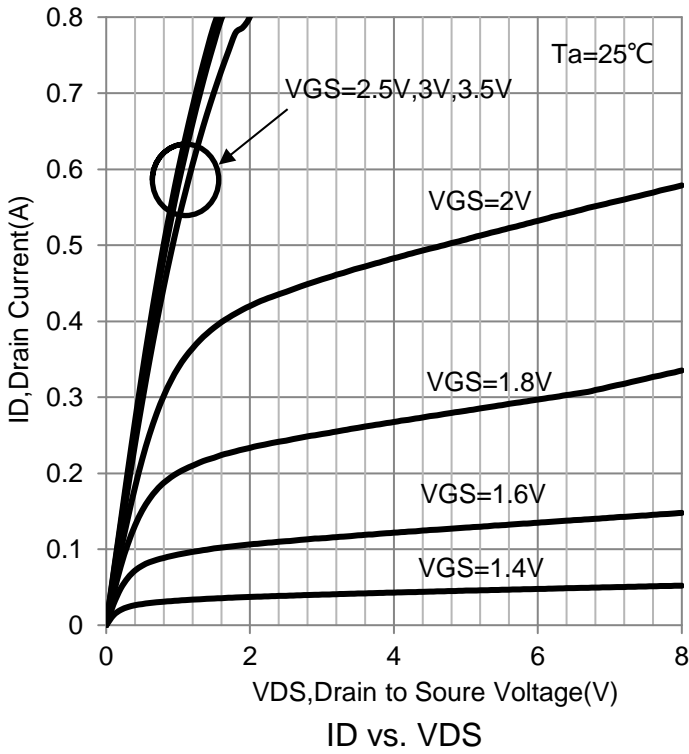



+9/% & -&\$530/*\$4 \$0 -5%

5.ELECTRICAL CHARACTERISTICS CURVES (Con.)

N-Channel

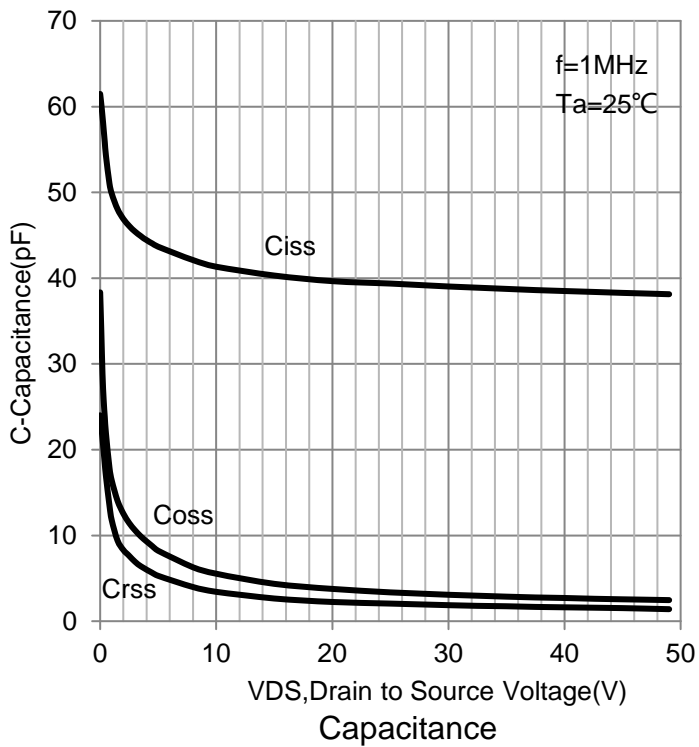
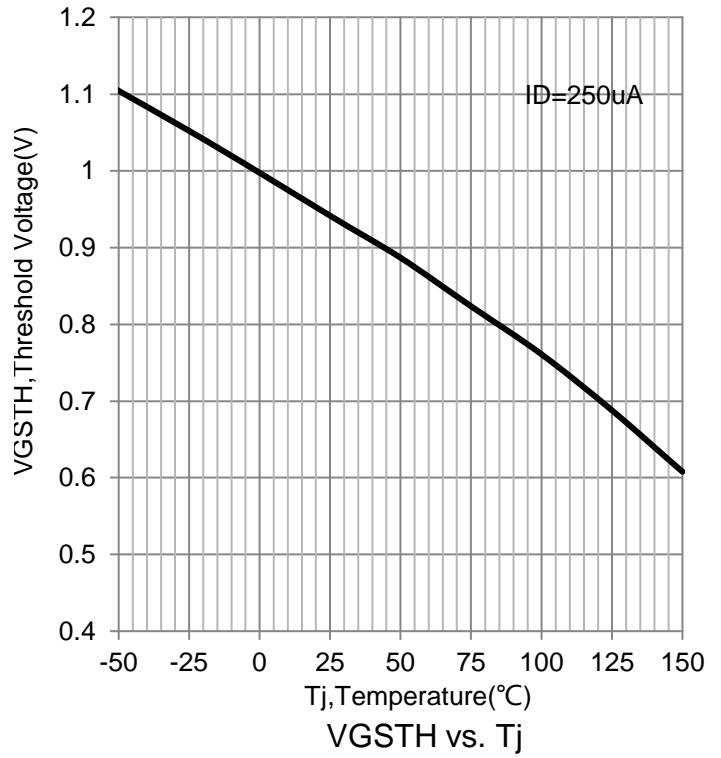
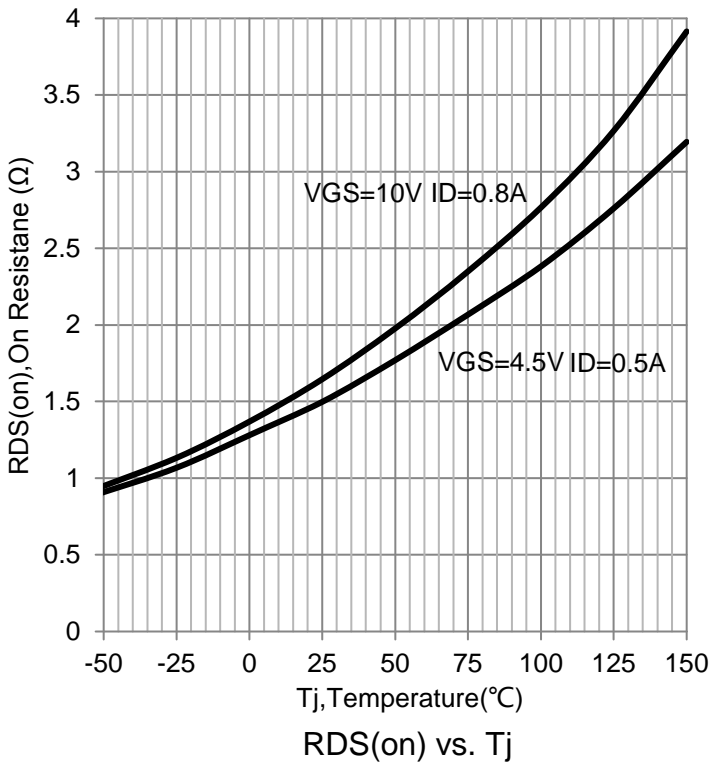



5. ELECTRICAL CHARACTERISTICS CURVES (Con.)

P-Channel

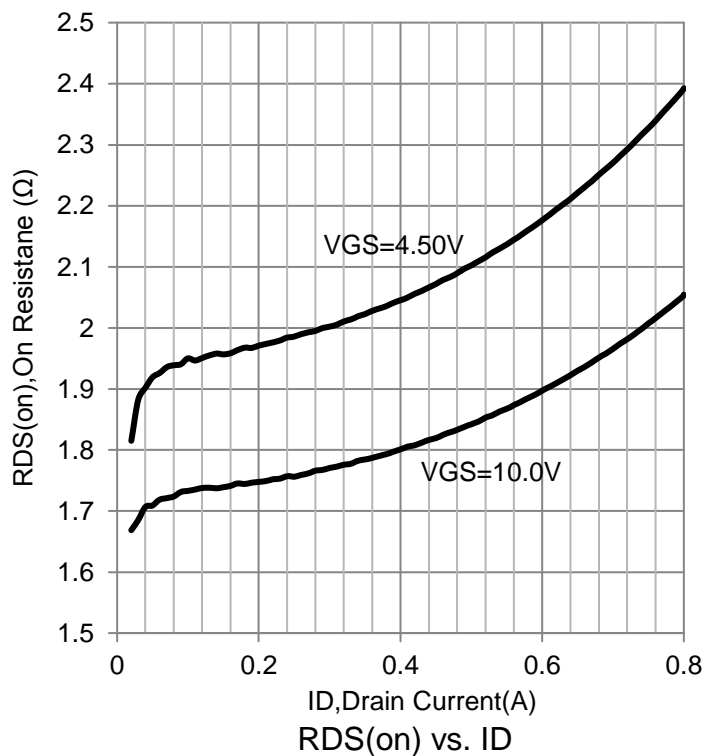
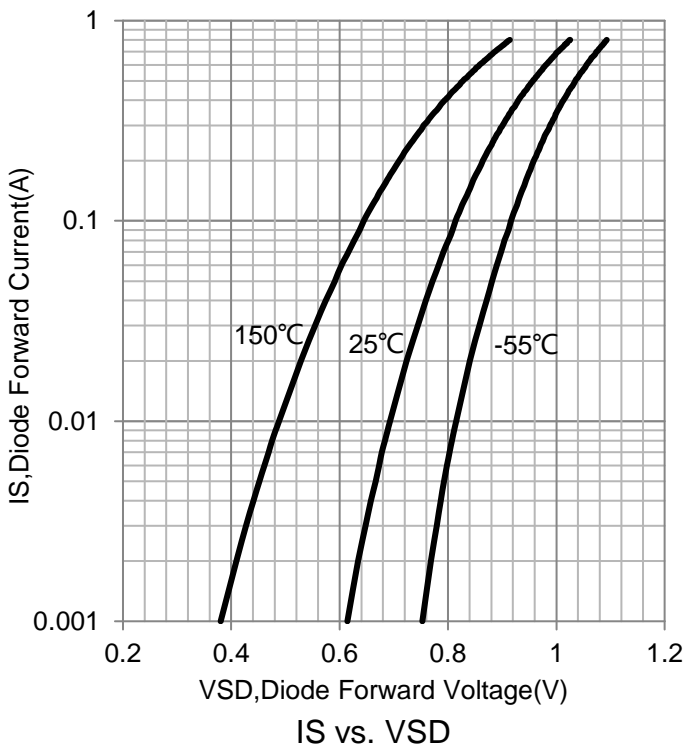
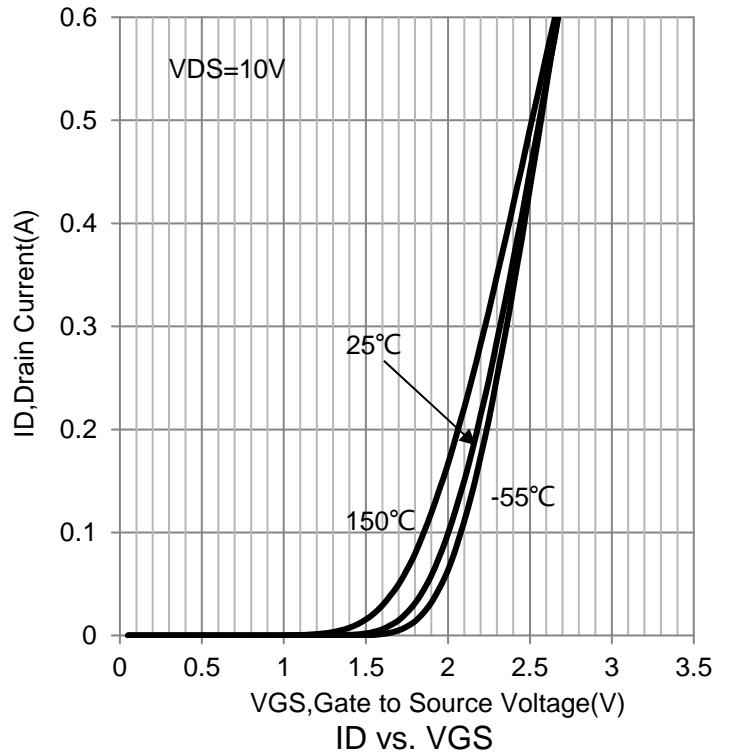
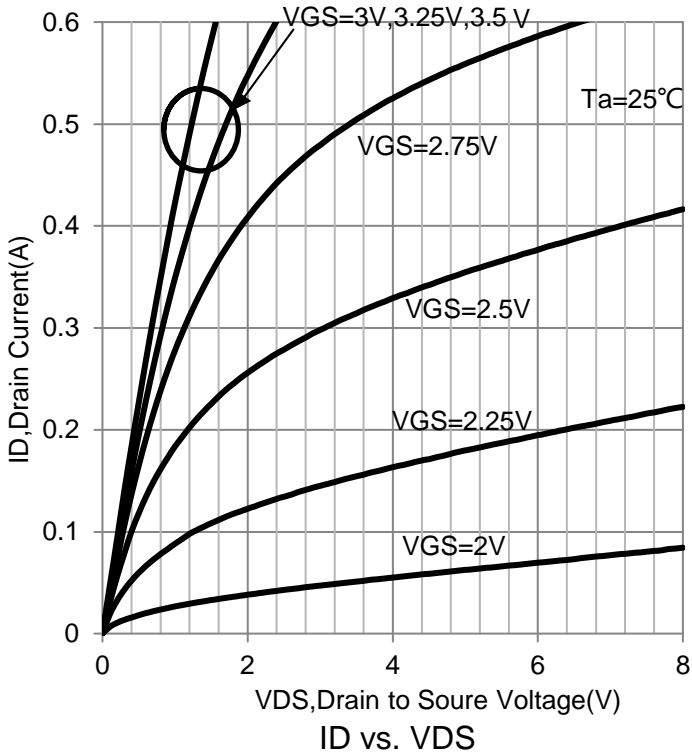



5. ELECTRICAL CHARACTERISTICS CURVES (Con.)

P-Channel

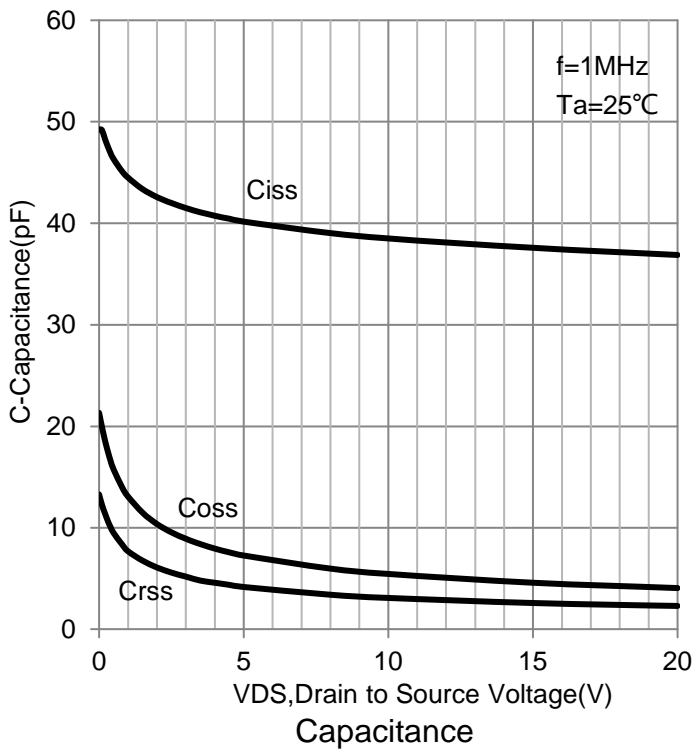
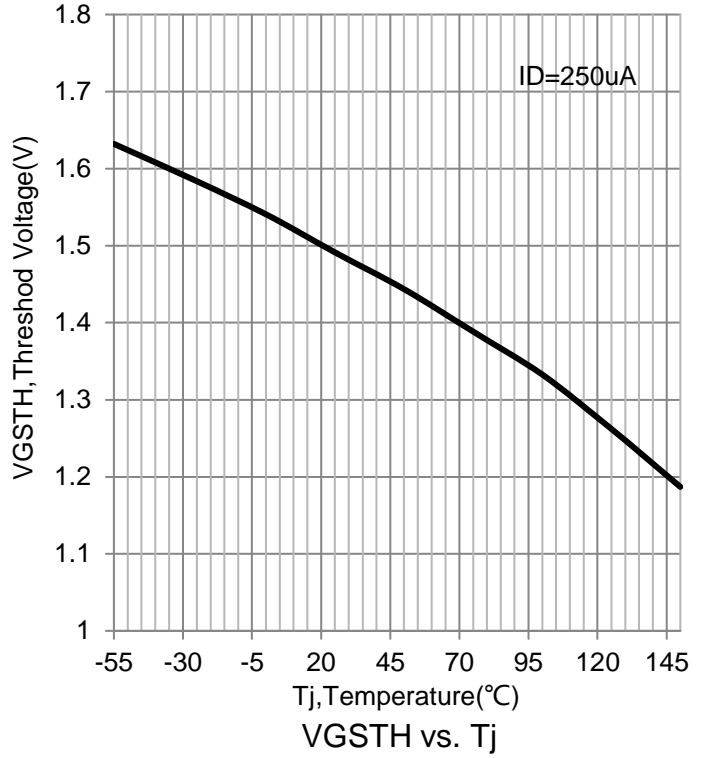
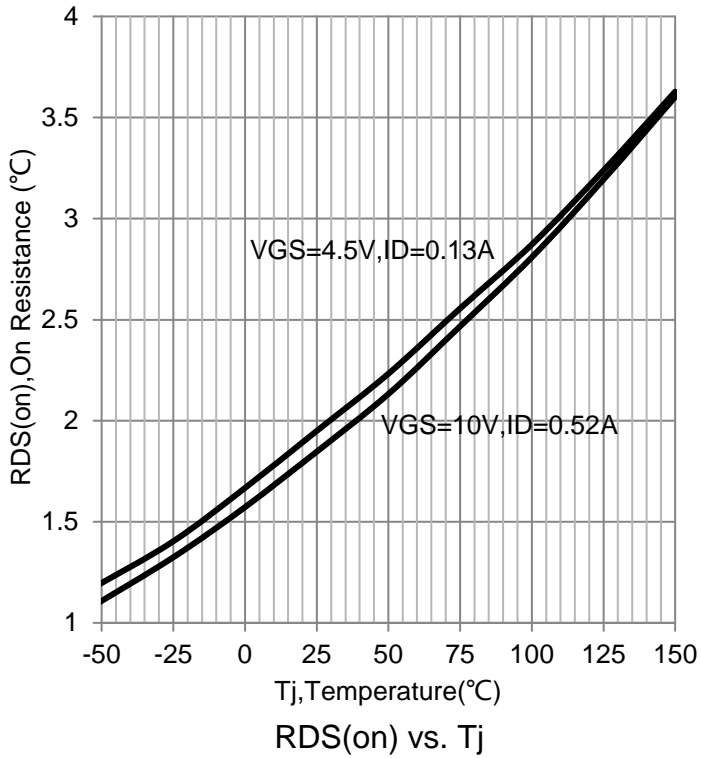

6.OUTLINE AND DIMENSIONS

Notes:

1. DIMENSIONING AND TOLERANCING PER ANSI Y14.5M, 1982.
2. CONTROLLING DIMENSION: MILLIMETERS.
3. MAXIMUM LEAD THICKNESS INCLUDES LEAD FINISH. MINIMUM LEAD THICKNESS IS THE MINIMUM THICKNESS OF BASE MATERIAL.
4. DIMENSIONS D AND E1 DO NOT INCLUDE MOLD FLASH, PROTRUSIONS OR GATE BURRS.

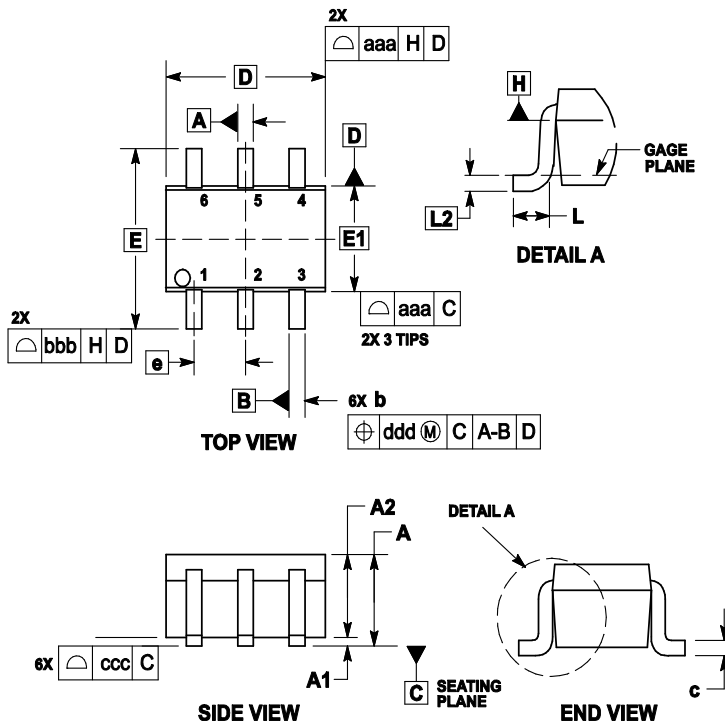

DIM	MILLIMETERS			INCHES		
	MIN	NOM	MAX	MIN	NOM	MAX
A	---	---	1.10	---	---	0.043
A1	0.00	---	0.10	0	---	0.004
A2	0.70	0.90	1.00	0.027	0.035	0.039
b	0.15	0.20	0.25	0.006	0.008	0.01
C	0.08	0.15	0.22	0.003	0.006	0.009
D	1.80	2.00	2.20	0.07	0.078	0.086
E	2.00	2.10	2.20	0.078	0.082	0.086
E1	1.15	1.25	1.35	0.045	0.049	0.053
e	0.65 BSC			0.026 BSC		
L	0.26	0.36	0.46	0.010	0.014	0.018
L2	0.15 BSC			0.006 BSC		
aaa	0.15			0.01		
bbb	0.30			0.01		
ccc	0.10			0.00		
ddd	0.10			0.00		

7.SOLDERING FOOTPRINT

