

78L09 Three-terminal positive voltage regulator

SOT-89-3L

FEATURES

- Maximum output current
 $I_{OM}: 0.1A$
- Output voltage
 $V_O: 9V$
- Continuous total dissipation
 $P_D: 0.6 W (T_a= 25 ^\circ C)$

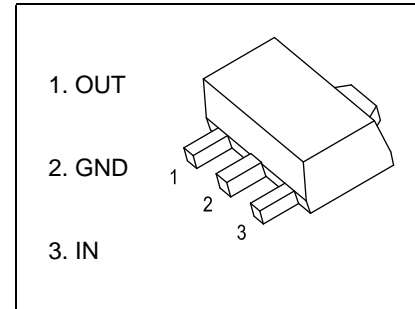

ABSOLUTE MAXIMUM RATINGS (Operating temperature range applies unless otherwise specified)

Parameter	Symbol	Value	Unit
Input Voltage	V_i	30	V
Thermal Resistance from Junction to Ambient	$R_{\theta JA}$	166.7	$^\circ C/W$
Operating Junction Temperature Range	T_{OPR}	-40~+125	$^\circ C$
Storage Temperature Range	T_{STG}	-65~+150	$^\circ C$

ELECTRICAL CHARACTERISTICS AT SPECIFIED VIRTUAL JUNCTION TEMPERATURE ($V_i=16V, I_o=40mA, C_i=0.33\mu F, C_o=0.1\mu F$, unless otherwise specified)

Parameter	Symbol	Test conditions	Min	Typ	Max	Unit	
Output voltage	V_o	$25^\circ C$	8.64	9.0	9.36	V	
		$0-125^\circ C$	$12V \leq V_i \leq 24V, I_o=1mA-40mA$	8.55	9.0	9.45	V
			$I_o=1mA-70mA$	8.55	9.0	9.45	V
Load Regulation	ΔV_o	$I_o=1mA-100mA, 25^\circ C$		19	90	mV	
		$I_o=1mA-40mA, 25^\circ C$		11	40	mV	
Line regulation	ΔV_o	$12V \leq V_i \leq 24V, 25^\circ C$		45	175	mV	
		$13V \leq V_i \leq 24V, 25^\circ C$		40	125	mV	
Quiescent Current	I_q	$25^\circ C$		4.1	6.0	mA	
Quiescent Current Change	ΔI_q	$13V \leq V_i \leq 24V, 0-125^\circ C$			1.5	mA	
	ΔI_q	$1mA \leq I_o \leq 40mA, 0-125^\circ C$			0.1	mA	
Output Noise Voltage	V_N	$10Hz \leq f \leq 100KHz, 25^\circ C$	58			$\mu V/V_o$	
Ripple Rejection	RR	$15V \leq V_i \leq 25V, f=120Hz, 0-125^\circ C$	37	45		dB	
Dropout Voltage	V_d	$25^\circ C$		1.7		V	

* Pulse test.

TYPICAL APPLICATION

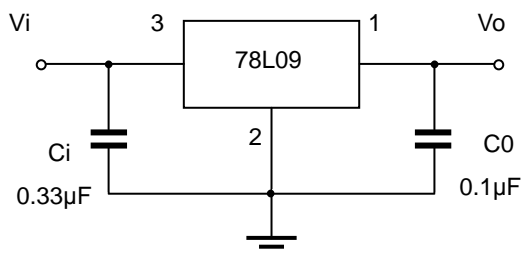

Note: Bypass capacitors are recommended for optimum stability and transient response and should be located as close as possible to the regulator pins.

Typical Characteristics

Output Characteristics

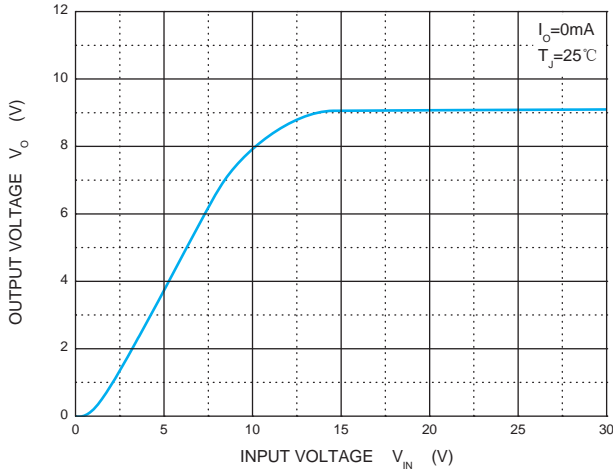

Dropout Characteristics

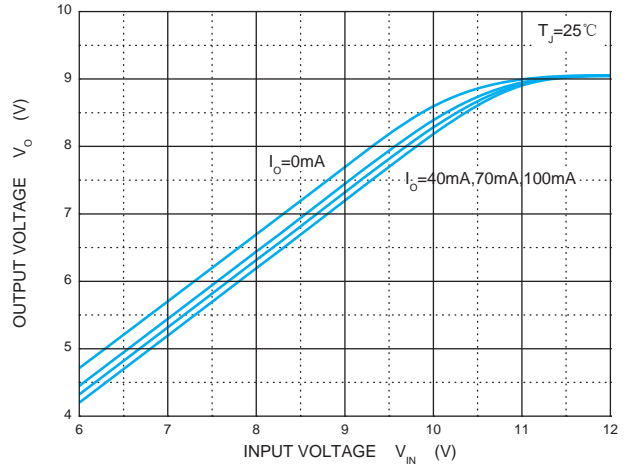

Quiescent Current vs Input Voltage

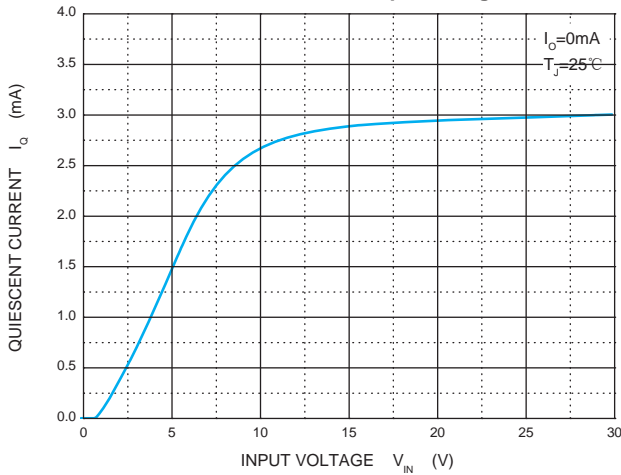

Current Cut-off Grid Voltage

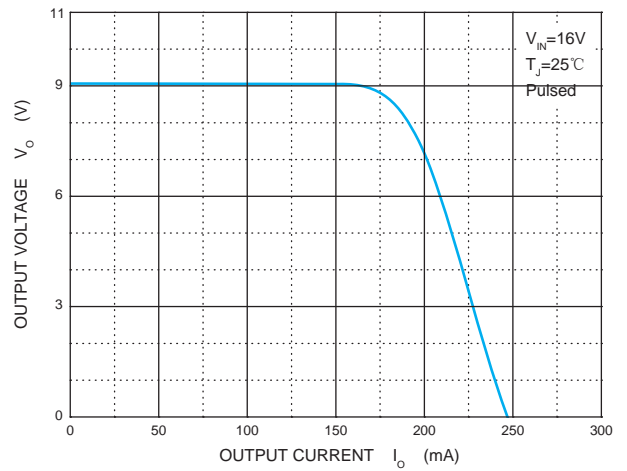

Output Voltage vs Junction Temperature

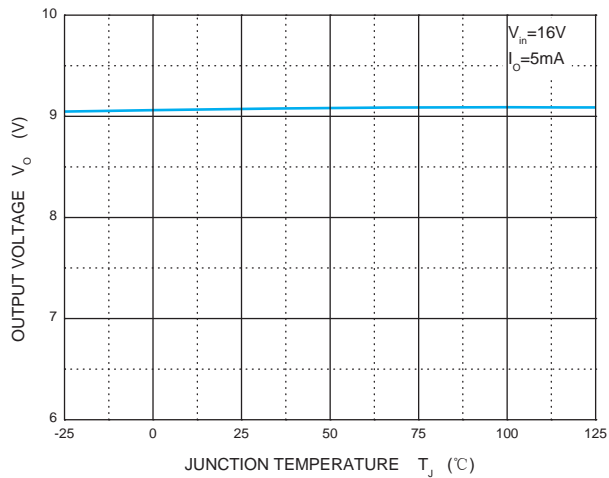

Power Derating Curve

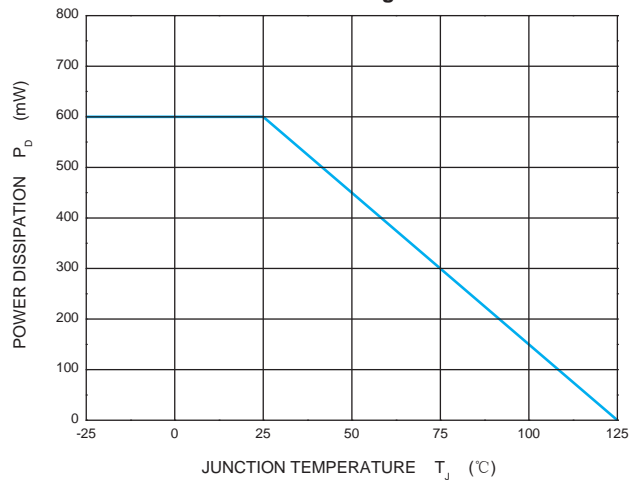

Outline Drawing

SOT-89-3L Package Outline Dimensions

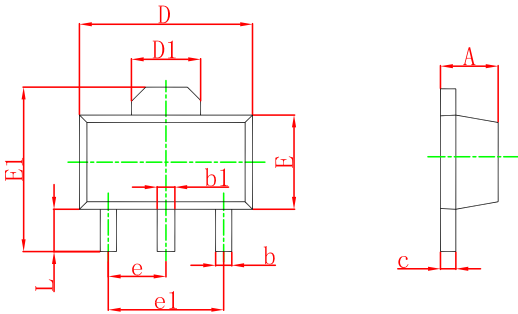

Symbol	Dimensions In Millimeters		Dimensions In Inches	
	Min	Max	Min	Max
A	1.400	1.600	0.055	0.063
b	0.320	0.520	0.013	0.020
b1	0.400	0.580	0.016	0.023
c	0.350	0.440	0.014	0.017
D	4.400	4.600	0.173	0.181
D1	1.550 REF.		0.061 REF.	
E	2.300	2.600	0.091	0.102
E1	3.940	4.250	0.155	0.167
e	1.500 TYP.		0.060 TYP.	
e1	3.000 TYP.		0.118 TYP.	
L	0.900	1.200	0.035	0.047

SOT-89-3L Suggested Pad Layout

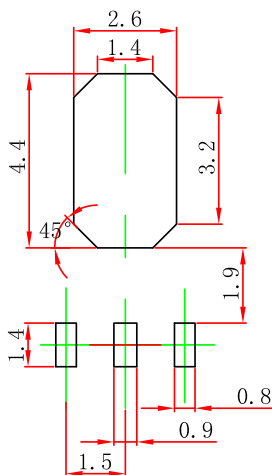

Note:

1. Controlling dimension: in/millimeters.
2. General tolerance: $\pm 0.05\text{mm}$.
3. The pad layout is for reference purposes only.

PACKAGE SPECIFICATIONS

Package	Reel Size	Reel DIA. (mm)	Q'TY/Reel (pcs)	Box Size (mm)	QTY/Box (pcs)	Carton Size (mm)	G.W.(Kg)
SOT-89-3L	7'	330	1000	203×203×195	40000	438×438×220	180000