

FEATURES and Benefits

- Low voltage overshoot
- Low on-state voltage
 - Does not degrade surge capability after multiple surge events within limit
- Fails short circuit when surged in excess of ratings
- Low capacitance
- Low inductance
- High temperature soldering guaranteed:260°C/10 seconds.
- Weight: 0.088g



MECHANICAL DATA

Case: JEDEC DO-214AA molded plastic

Applicable Global Standards

- TIA-968-A
- ITU K.20/21 Enhanced level
- ITU K.20/21 Basic level
- GR 1089 inter building
- IEC 6100-4-5
- YD/T 1082 ;YD/T 993 ;YD/T 950

1.Electrical Parameters

Parameter	Definition
C_o	Off-state Capacitance - typical capacitance measured in off state
I_s	Switching Current - maximum current required to switch to on state
I_{DRM}	Leakage Current - maximum peak off-state current measured at V_{DRM}
I_H	Holding Current - minimum current required to maintain on state
I_{PP}	Peak Pulse Current - maximum rated peak impulse current
I_T	On-state Current - maximum rated continuous on-state current
V_s	Switching Voltage - maximum voltage prior to switching to on state
V_{DRM}	Peak Off-state Voltage - maximum voltage that can be applied while maintaining off state
V_T	On-state Voltage - maximum voltage measured at rated on-state current
V_{PP}	Peak Pulse Voltage - maximum rated peak impulse voltage

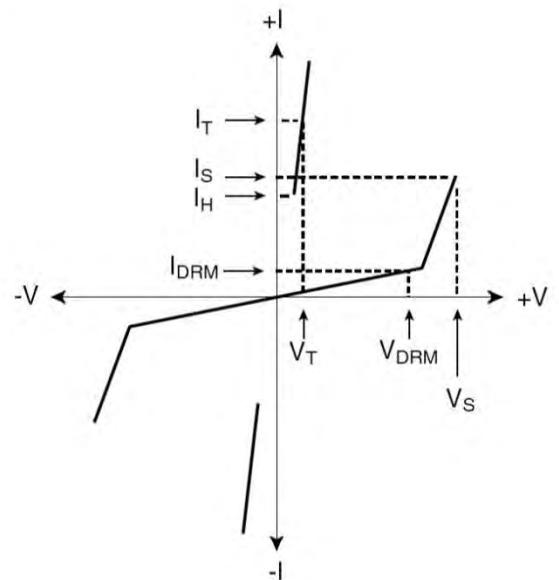

2.ELECTRICAL CHARACTERISTICS CURVES

LP0080SC - LP5000SC Series - DO-214AA (SMB)

@10/700 μ s, 4KV

Part Number	Marking	V_{DRM} @ $I_{DRM}=5\mu A$	V_S @100V/ μ s	V_T @ $I_T=2.2A$	I_S	I_T	I_H	Capacitance @1MHz,2V bias	
		V min	V max	V max	mA max	A max	mA min	pF min	pF max
P0080SC	P-8C	6	25	4	800	2.2	50	25	150
P0300SC	P03C	25	40	4	800	2.2	50	15	140
P0640SC	P06C	58	77	4	800	2.2	150	40	60
P0720SC	P07C	65	88	4	800	2.2	150	35	60
P0900SC	P09C	75	98	4	800	2.2	150	25	55
P1100SC	P11C	90	130	4	800	2.2	150	30	50
P1300SC	P13C	120	160	4	800	2.2	150	25	45
P1500SC	P15C	140	180	4	800	2.2	150	25	40
P1800SC	P18C	170	220	4	800	2.2	150	25	35
P2000SC	P20C	180	220	4	800	2.2	150	20	35
P2300SC	P23C	190	260	4	800	2.2	150	25	35
P2600SC	P26C	220	300	4	800	2.2	150	20	35
P3100SC	P31C	275	350	4	800	2.2	150	20	35
P3500SC	P35C	320	400	4	800	2.2	150	20	35
P4000SC	P40C	360	460	4	800	2.2	150	20	35
P4500SC	P45C	400	540	4	800	2.2	150	20	35
P5000SC	P50C	440	600	4	800	2.2	150	20	35

Notes:

- Absolute maximum ratings measured at TA= 25 °C (unless otherwise noted) .
- Devices are bi-directional.

3.Surge Ratings

Series	I_{PP}					V_{PP}	I_{TSM} 50/60 Hz	di/dt
	2/10 μ s ¹	8/20 μ s ¹	10/160 μ s ¹	10/560 μ s ¹	10/1000 μ s ¹	5/310 μ s ¹		
	2/10 μ s ²	1.2/50 μ s ²	10/160 μ s ²	10/560 μ s ²	10/1000 μ s ²	10/700 μ s ²	A min	Amps/ μ s max
C	500	400	200	150	100	4	30	500

Notes:- Peak pulse current rating (I_{PP}) is repetitive and guaranteed for the life of the product.

1. CL - I_{PP} ratings applicable overtemperature range of -40°C to +85°C
2. Vo - The device must initially be in thermal equilibrium with -40°C < T_J < +150°C

4.Thermal Considerations

Package	Symbol	Parameter	Value	Unit
DO-214AA	T _J	Operating Junction Temperature Range	-40 to +150	°C
	T _S	Storage Temperature Range	-40 to +150	°C
	R _{θJA}	Thermal Resistance: Junction to Ambient	160	°C/W

5. ELECTRICAL CHARACTERISTICS CURVES

Figure 1 - V-I Characteristics

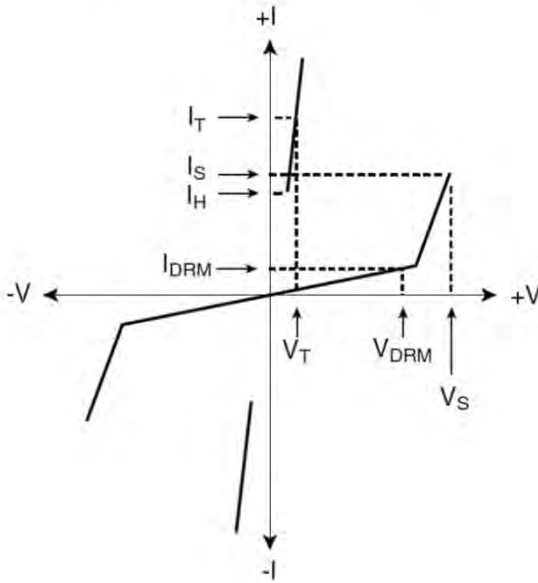

Figure 2 - $t_r \times t_d$ Pulse Waveform

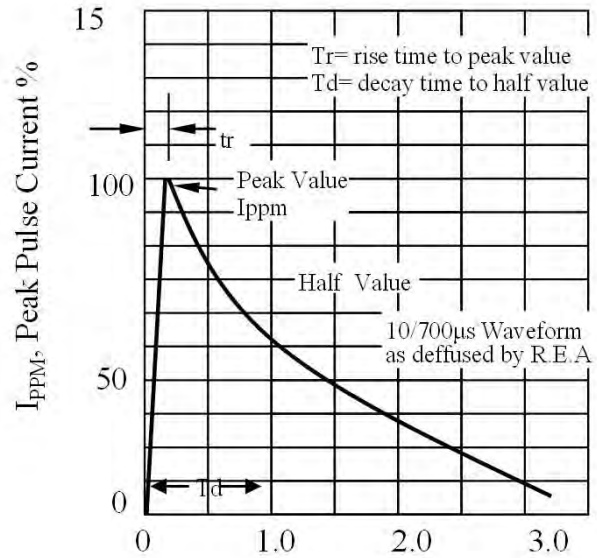

Figure 3 - Normalized V_S Change vs. Junction Temperature

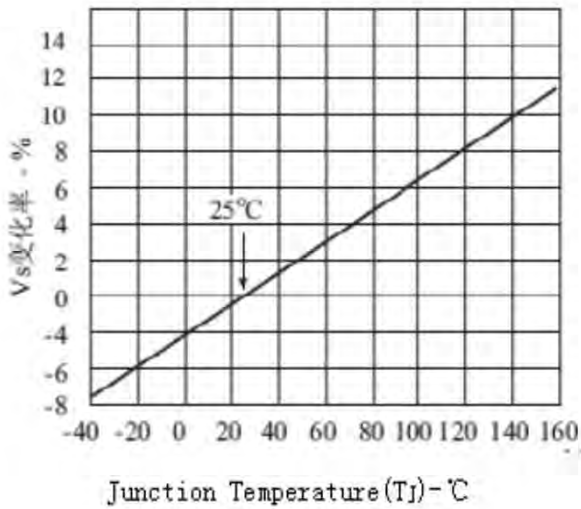
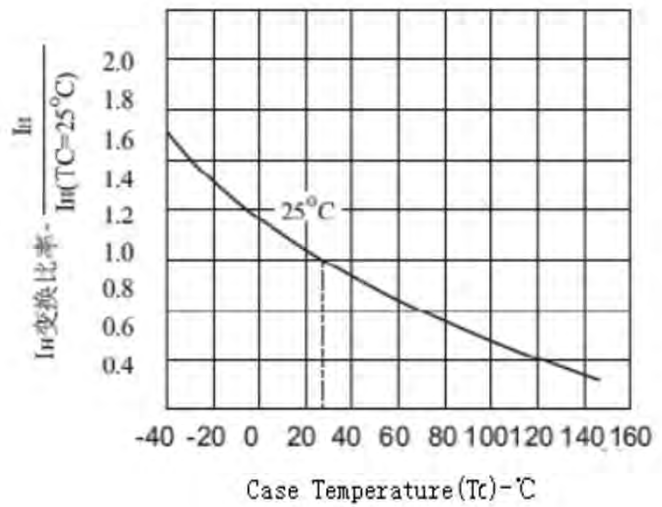
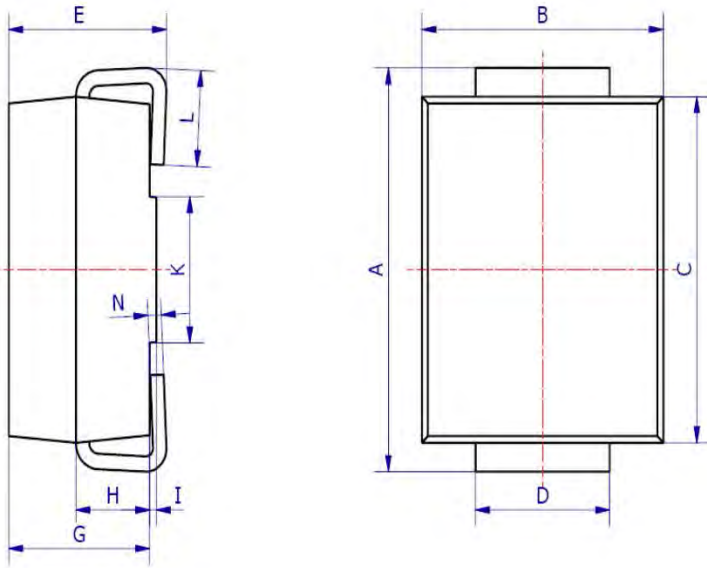

Figure 4 - Normalized DC Holding Current vs. Case Temperature



6.OUTLINE AND DIMENSIONS



SMB			
DIM	Min	Max	Typ.
A	5.00	5.45	5.25
B	3.20	4.00	3.60
C	4.30	4.70	4.50
D	1.80	2.20	2.00
E	2.20	2.50	2.35
G	1.90	2.30	2.10
H	0.95	1.25	1.10
I	0.05	0.15	0.10
K	1.70	2.10	1.90
L	0.90	1.60	1.30
N	0.10	0.30	0.20
All Dimensions in mm			

7.SOLDERING FOOTPRINT

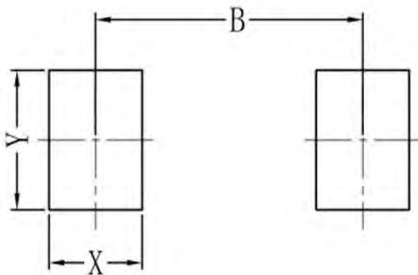

SMB	
DIM	(mm)
X	1.60
Y	2.20
B	4.60